

TELEQUIPMENT



©

TELEQUIPMENT is a registered trade mark of TEKTRONIX U.K. LTD.

Curve Tracer Type CT71

INSTRUCTION MANUAL

Issue 1
March 1981
© Copyright (1978) by
Tektronix U.K. Ltd.

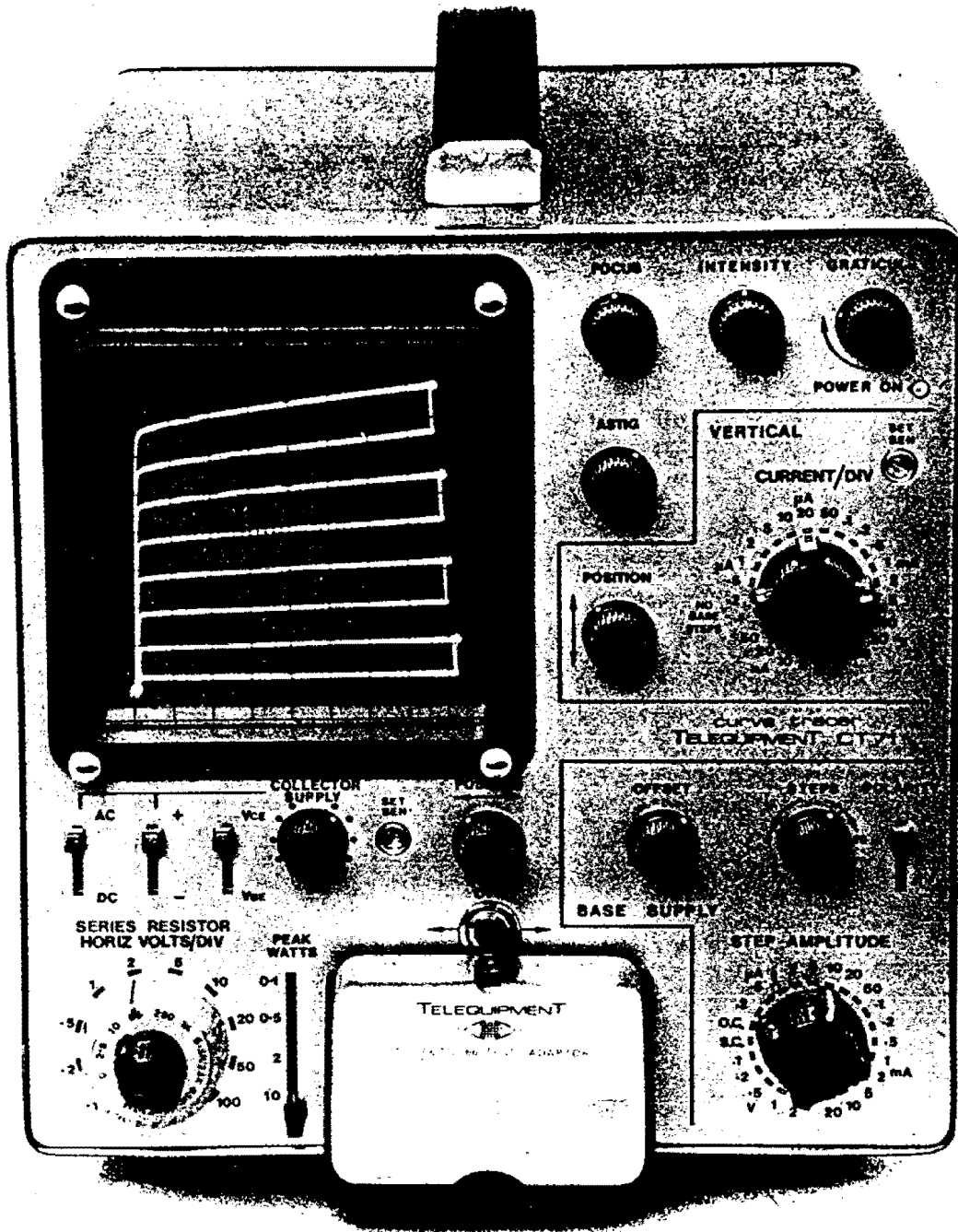

WARNING

To comply with the U.K. Health and Safety Act 1974, the following warning should be observed.

BY DELIBERATE OPERATOR EFFORT THE SAFETY COVER OVER THE TEST ADAPTOR COULD BE FORCED OPEN REVEALING TERMINALS WITH VOLTAGES TO 1,000 V.

INTRODUCTION

The CT71 Curve Tracer is used for the display and measurement of the dynamic characteristics of transistors, FET's and diodes. Several different transistor characteristics may be displayed, including the collector family in the common emitter configuration.

A cursor is stored in the pocket at the front of this Manual to assist in measuring the slope of the displayed characteristic, particularly Output Admittance (h_{oe}) on transistors, Dynamic Resistance (r_d) on diodes and Dynamic Resistance (r_z) on zener diodes.

The appropriate edge of the cursor is held against the graticule, tangential to the required point on the displayed curve. Read off ΔV on X axis and ΔI on Y axis using the maximum number of divisions in both directions for the greatest accuracy. It may be necessary to alter the position of the trace on the screen to suit the cursor.

The design of this instrument is subject to continuous development and improvement, consequently this instrument may incorporate minor changes in detail from the information contained herein, which would, in the main, affect the Components List and Circuit Diagrams. The reader should therefore pay particular attention to the notes at the beginning of Section 5.

Throughout this manual all references to front panel controls are in full capital letters, e.g., POSITION.

SERVICING

In the event of this Instrument being returned to TELEQUIPMENT for servicing: the owner is requested to remove the power supply plug and *NOT* send the following items unless they are suspect, in order to prevent damage during transit and facilitate packaging:

Manual.
Power Supply Lead.
Test Fixtures.

CONTENTS

Chapter	Page	Chapter	Page
1 SPECIFICATION		4 MAINTENANCE AND CALIBRATION	
Cathode Ray Tube (CRT)	1/1	Calibration	4/1
Collector Supply	1/1	CRT	4/3
Horizontal Amplifier	1/1	Horizontal Amplifier	4/2
Power requirements	1/1	Preliminary procedure	4/1
Size	1/1	Step Generator	4/2
Step Generator	1/1	Vertical Amplifier	4/2
Temperature limits	1/1	Fault Diagnosis	4/1
Vertical Amplifier	1/1	Chart	4/4
Weight	1/1	General	
2 OPERATING INSTRUCTIONS		Horizontal accuracy	4/1
Applications	2/3	Vertical accuracy	4/1
Diodes	2/3	Mechanical	
Thyristors, Triacs, etc.	2/9	Access to interior	4/1
Transistors		CRT removal and fitting	4/1
Bipolar	2/5	Table 1	4/5
Field Effect	2/8	Table 2	4/6
Unijunction	2/11	Series Resistor Value Chart	4/7
Controls		Table 3	4/7
Base supply	2/1	Table 4	4/8
CRT	2/1	5 COMPONENT LIST	
Horizontal	2/1	Assembly	5/8
Vertical	2/1	Components	5/2
Operation	2/2	Mechanical	5/9
Pre-operational checks	2/1	6 CIRCUIT DIAGRAMS	
Test Fixtures	2/1	Collector supply	4
Testing devices	2/3	Component Reference:	
3 CIRCUIT DESCRIPTIONS		PC Board No. 96	6
Block Diagram	3/1	PC Board No. 97	8
CRT	3/3	PC Board No. 98	7
Collector Supply	3/2	Horizontal Amplifier	1
Horizontal Amplifier	3/1	Power supply & CRT	5
Power Supply	3/3	Step Generator	3
Step Generator	3/2	Vertical Amplifier	2
Vertical Amplifier	3/2		

SECTION 1

SPECIFICATION

1.1 COLLECTOR SUPPLY				
Open-circuit voltage	0—1 kV, continuously variable
Polarity	+ or —
Modes	A.C. (full-wave rectified) or D.C.
Maximum current	2 A
Maximum power dissipation	0.1, 0.5, 2 and 10 W
Series resistor	0, 2.5, 10, 65, 250, 1 k, 6.5 k, 25 k, 85 k, 500 k and 1.7 M
1.2 STEP GENERATOR				
Number of steps	0—10 min.
Step amplitude — current	0.2 μ A—20 mA/step, 16 ranges in 1-2-5 sequence
— voltage	0.1 — 2 V/step, 5 ranges in 1-2-5 sequence
Polarity	+ or —
Accuracy	5%
Step offset	± 1 step continuously variable
1.3 VERTICAL AMPLIFIER				
Collector current range	5 nA—0.2 A/division, 24 ranges in 1-2-5 sequence
Accuracy	5%
1.4 HORIZONTAL AMPLIFIER				
Collector or base voltage range	0.1 V—100 V/division, 10 ranges in 1-2-5 sequence
Accuracy	5%
1.5 CATHODE RAY TUBE				
Display area	10 x 10 cm
Overall CRT voltage	2.5 kV
Phosphor	P31
1.6 POWER REQUIREMENTS				
Voltages	100-125 in 5 V steps 200-250 V in 10 V steps
Power consumption	37.5 VA
Frequency	48—63 Hz
1.7 SIZE approx.				
Height	26 cm
Width	24 cm
Depth	47 cm
1.8 WEIGHT				
...	12.9 kg
1.9 TEMPERATURE LIMITS, ambient				
Operating	—15 to +40°C approx.
Non-operating	—25 to +70°C approx.

SECTION 2

OPERATING INSTRUCTIONS

2.1 FUNCTION OF CONTROLS AND TEST FIXTURES

2.1.1 CRT

- GRATICULE** controls graticule illumination.
- INTENSITY** varies the degree of brightness and may be adjusted for different displays.
- FOCUS** controls the definition of the display.
- ASTIG** is used in conjunction with **FOCUS** for best overall definition.

2.1.2 VERTICAL CURRENT/DIV

selects the vertical sensitivity of the display. The deflection factors range from 5 nA/DIV to 0.2 A/DIV.

- POSITION** moves trace along the vertical axis.

2.1.3 BASE SUPPLY

- POLARITY ±** selects the positive or negative-going current or voltage steps available from the step generator, to be applied between the base and emitter of the device.
- STEPS** determines the number of steps from 0 to 10.
- OFFSET** allows a variable amount of D.C. voltage to be added or subtracted from the step generator output and has a range of ± 1 step.
- STEP AMPLITUDE** determines the amplitude of each step from 0.2 μA to 20 mA current steps, or from 0.1 V to 2 V, voltage steps. In the O.C. position the base of the device is disconnected from the step generator. In the S.C. position the base and the emitter of the device are short circuited.

2.1.4 HORIZONTAL

- POSITION** moves the trace along the horizontal axis.
- COLLECTOR SUPPLY** is a variable voltage either in the form of positive or negative-going full-wave rectified sine wave or a D.C. voltage and may be varied from 0 to 1 kV.

- ±** determines the polarity of the **COLLECTOR SUPPLY** above.
- AC-DC** selects either the AC which is a full-wave rectified sine wave, or the DC.
- VCE-VBE** selects the horizontal parameter.
- PEAK WATTS** determines the maximum power output of the **COLLECTOR SUPPLY** in four ranges, viz.: 0.1, 0.5, 2 or 10 W, by selecting the **SERIES RESISTOR** in series with the **COLLECTOR SUPPLY**.
- SERIES RESISTOR** limits the collector current I_c and is connected in series with the **COLLECTOR SUPPLY**.

CAUTION. To avoid damage to the switch mechanism the settings of the **SERIES RESISTOR** given below should not be exceeded.

Peak Watt Setting	Series Resistor Setting	
	Minimum (Anticlockwise)	Maximum (Clockwise)
0.1	65	1.7 M
0.5	10	500 k
2.0	2.5	85 k
10	0	25 k

- HORIZ VOLTS/DIV** controls the horizontal sensitivity of the display and the maximum available collector voltage. Deflection factors range from 0.1 VOLTS/DIV to 100 VOLTS/DIV.

NOTE: The **HORIZ VOLTS/DIV** and **SERIES RESISTOR** controls interlock when the power limit set by the **PEAK WATTS** control is reached and cannot be exceeded when interlocked. Clockwise rotation of the **HORIZ VOLTS/DIV** also rotates the **SERIES RESISTOR** control, conversely anti-clockwise rotation of the **SERIES RESISTOR** control also rotates the **HORIZ VOLTS/DIV** control.

- DEVICE SELECT (labelled OFF)** selects either right or left sockets/terminals on the **TEST FIXTURES**.

- 2.1.5. TEST FIXTURES** two off viz: TO18 & TO5 and TO3 & TO66, plug into the front of the instrument.

2.2 PRE-OPERATIONAL CHECKS

- 2.2.1** Before connecting the equipment to the supply ensure that the voltage selector plug is set to the appropriate voltage range. Check that the rating of the fuse is 250 mA for 220-250 V or 500 mA for 100-125 V.

The Power Cord should be secured with the nuts and screws provided, to comply with local legislation.

NOTE: The 3 core supply lead is colour coded as follows:—

Line	Neutral	Earth (Chassis)
Brown	Blue	Green/Yellow

2.2.2 The controls on the front panel should be set as follows:—

1. CRT
 - GRATICULE Fully anti-clockwise
 - INTENSITY Fully anti-clockwise
 - FOCUS Mid-position
 - ASTIG Mid-position
2. VERTICAL
 - CURRENT/DIV 1 mA
 - POSITION Mid-position
3. BASE SUPPLY
 - POLARITY ± +
 - STEPS 0-10 0
 - OFFSET Fully clockwise
 - STEP AMPLITUDE 0.2 μ A

4. HORIZONTAL
 - POSITION Mid-position
 - COLLECTOR SUPPLY Minimum (fully anti-clockwise)
 - VCE-VBE VCE
 - ± +
 - AC-DC AC
 - PEAK WATTS 0.1
 - SERIES RESISTOR 250
 - HORIZ VOLTS/DIV 1
 - DEVICE SELECT SWITCH OFF

2.3 OPERATION

1. Plug into supply and switch on by the GRATICULE —POWER ON, check that the green indicator is alight.
2. Adjust GRATICULE for required illumination of graticule lines.
3. Adjust INTENSITY for required intensity of the spot.
4. Adjust FOCUS & ASTIG for best definition of the spot.
5. Adjust POSITION to centre spot in the vertical plane.
6. Adjust POSITION to centre spot in the horizontal plane.

TABLE 1

*When testing FET's, select VOLTS position of STEP AMPLITUDE switch.

Device	Type	Characteristic	Base Supply Polarity ± Switch	Horizontal Controls		
				AC-DC	±	VCE-VBE
Bipolar-Transistors common emitter configuration	NPN	VCE/VBE against I_C	+	AC	+	Select
	PNP	VCE/VBE against I_C	—	AC	—	Select
*FET's common source configuration	N-Channel (for depletion mode)	V _{DS} /V _{GS} against I_D	—	AC	+	Select
	N-Channel (for enhancement mode)	V _{DS} /V _{GS} against I_D	+	AC	+	Select
	P-Channel (for depletion mode)	V _{DS} /V _{GS} against I_D	+	AC	—	Select
	P-Channel (for enhancement mode)	V _{DS} /V _{GS} against I_D	—	AC	—	Select
Diodes Connect cathode and anode to E & C terminals respectively	Forward		Not used (set STEP AMPLITUDE switch to O.C. & Polarity to +)	AC	+	VCE
	Reverse		Not used (set STEP AMPLITUDE switch to O.C. & Polarity to +)	AC	—	VCE
Zener diodes Connect cathode and anode to E & C terminals respectively	Breakdown		Not used (set STEP AMPLITUDE switch to O.C. & Polarity to +)	AC	—	VCE
Tunnel and back diodes Connect cathode & anode to E & C terminals respectively	Tunnel-direction (Forward)		Not used (set STEP AMPLITUDE switch to O.C. & Polarity to +)	AC	+	VCE
SCR's	PNPN P-gate)	Forward (Anode)	+	AC	+	VCE
	NPNP (N-gate)	Forward (Anode)	—	AC	—	VCE

2.4 TESTING DEVICES

1. Plug in appropriate TEST FIXTURE.
2. Connect the device or devices.
3. Set controls as given in Table 1.
4. Set PEAK WATTS within the power dissipation rating of the device.
5. Switch DEVICE SELECT to the device to be tested.
6. Increase COLLECTOR SUPPLY, STEP AMPLITUDE and STEPS as required.
7. Adjust SERIES RESISTOR, HORIZ VOLTS/DIV and CURRENT/DIV as necessary. Note the display on the CRT. Adjust POSITION controls as necessary.

NOTE: In order to obtain a reasonable display on the CRT, it may be necessary to set the PEAK WATTS to a higher setting which permits selection of a low value SERIES RESISTOR.

CAUTION. Reference note above. Care must be taken when increasing the COLLECTOR SUPPLY not to exceed the device dissipation.

8. When matching two devices of the same type; these should be connected, one to each side of the appropriate TEST FIXTURE and selected alternately with the DEVICE SELECT control. Set the other controls as given in TABLE 1 and compare the display.

NOTE: OFFSET may be used to set the collector current to any desired value. However for large signal h_{FE} measurements on bipolar transistors and V_{CS} measurements on FET's, the OFFSET control should be set as described in the Application Section. 2.5.

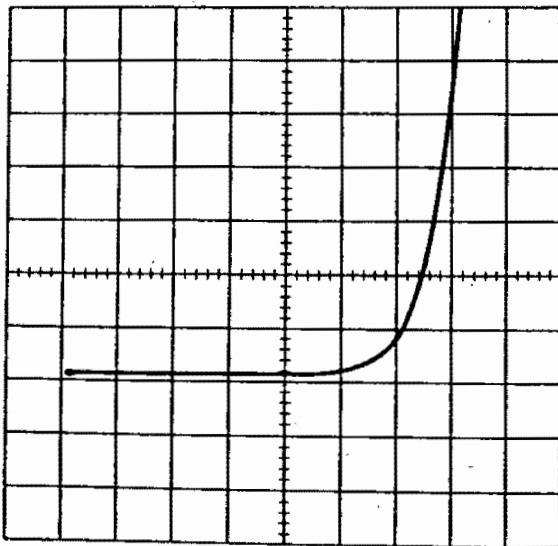

I_F 1mA/div V_F 0.1 V/div

Plate 1. Silicon Diode, 1N914, Forward characteristic

2.5 APPLICATIONS

2.5.1 This section describes the facilities provided by the Curve Tracer to measure the basic parameters of bipolar and field effect transistors, silicon controlled rectifiers, zener, tunnel and back diodes.

2.5.2 The procedures to measure the parameters of the devices mentioned above are detailed below. Where measurements are complex these have been explained in detail.

2.6 DIODES

2.6.1 The following illustrated parameters can be measured:—

1. The forward voltage drop V_F at any value of forward current I_F between 2 nA and 2 A.
Reference Plate 1,
2. The reverse voltage drop V_R at any value of reverse current I_R down to 2 nA.
Reference Plate 2, below
3. The reverse breakdown voltage $V_{(BR)}$, including zener diodes up to 1 kV.
Reference Plate 3, overleaf
4. The peak voltage V_P , the valley voltage V_V , the peak current I_P and the valley current I_V for tunnel diodes.
Reference Plate 4, overleaf
5. The positive differential or dynamic resistance at any point on the forward or reverse characteristics.

NOTE: Where the resistance is negative, that portion of characteristic cannot be displayed.

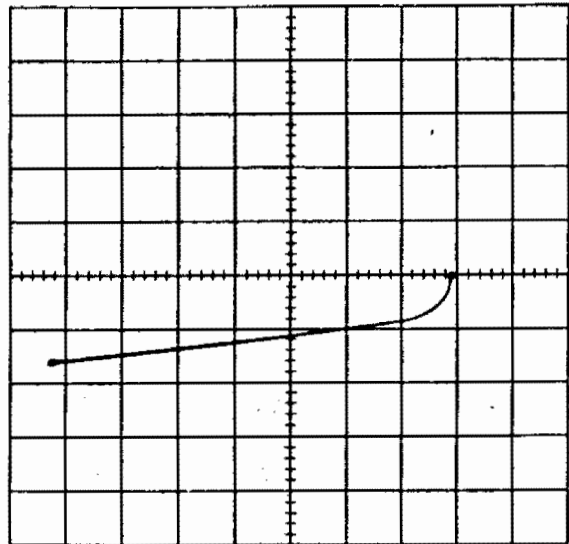

I_R 2 μ A/div V_R 0.5 V/div
Plate 2. Germanium Diode, AAY30,
Reverse characteristic

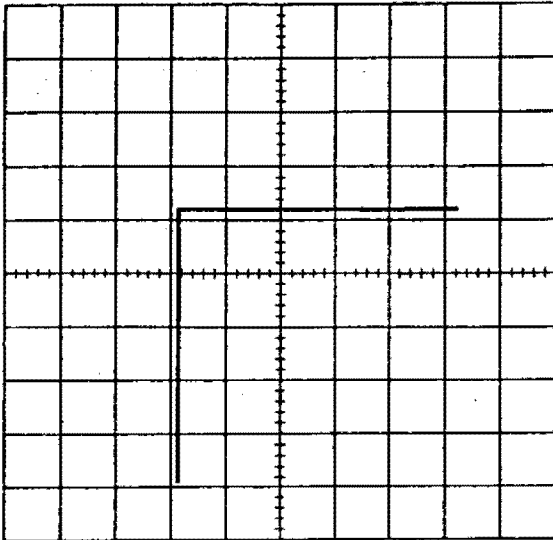

I_Z 2 mA/div V_Z 2 V/div
Plate 3. 11 V Zener Diode characteristic

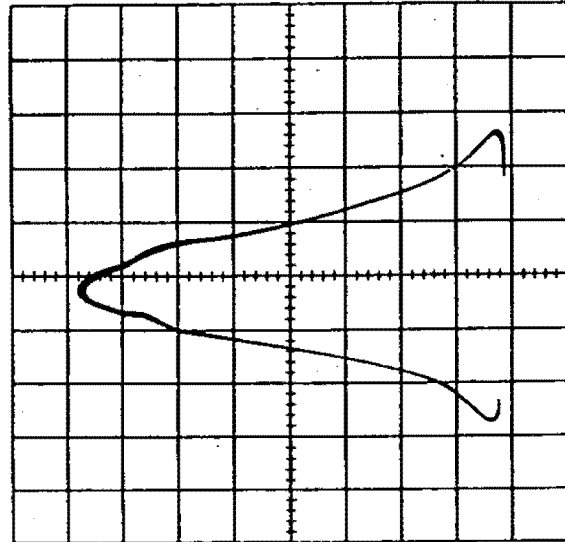

I_R 50 nA/div V_R 1 V/div
Plate 5. Diode Junction capacitance effect. 1N4001

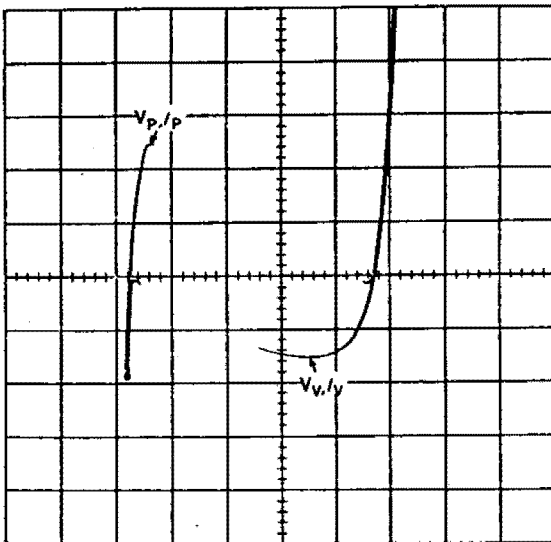

I_F 0.5 mA/div V_F 0.1 V/div
Plate 4. Tunnel Diode characteristic

2.6.2 In order to measure the parameters listed in 2.C.1 the forward or reverse characteristics are displayed by setting:—

1. The controls as detailed in Table 1.
2. STEP AMPLITUDE to O.C.
3. POLARITY \pm to +.
4. STEPS fully anti-clockwise.
5. OFFSET fully clockwise.

NOTE: These settings reduce the pick-up from the step generator.

2.6.3 When measuring very low values of reverse current, the junction capacity of the device may make the measurement difficult when AC-DC switch is set to AC. This is because the current flowing through a capacitor gives a display which is semi-circular and is superimposed on the normal reverse leakage characteristic of the diode. This effect is further complicated by the fact that the junction capacity is a non-linear function of voltage and distorts the semi-circle by increasing the vertical deflection at low voltages.

2.6.4 To avoid the above effect, set AC-DC switch to DC. This gives a spot which moves along the diode characteristic as the COLLECTOR SUPPLY control is rotated. As the DC collector supply has some ripple at twice supply frequency superimposed on it, when measuring devices with high junction capacity or passing high currents, the spot will deteriorate into a line or semi-circle.

2.6.5 The display, obtained when AC-DC switch is set to AC, can be used to compare the capacities of devices and give some indication of the actual capacity either by comparing the display with that of a known capacitor or calculating the impedance, at twice the supply frequency, by dividing the peak-to-peak voltage swing by the peak-to-peak current swing.

2.6.6 When checking devices of very low capacity, the internal capacitance of the TEST FIXTURES (approx. 1 pF) may become objectionable. In this case the device should be connected directly between the 'C' and 'E' sockets on the instrument.

CAUTION. Care should be taken as the safety interlock is inoperative when the TEST FIXTURE is removed and high voltages may be present at the 'C' sockets.

2.7 BIPOLAR TRANSISTORS

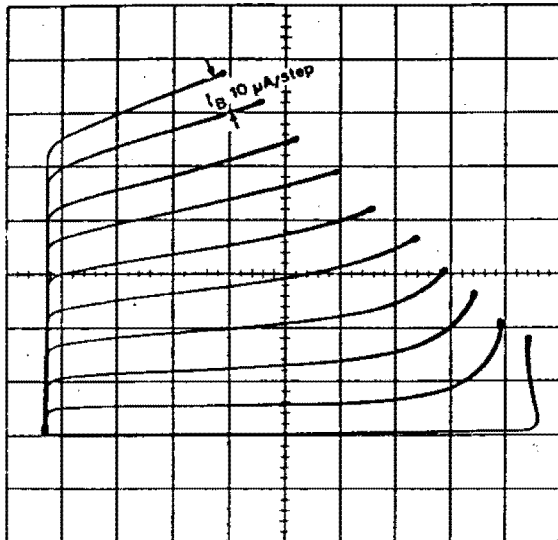

I_C 5 mA/div V_{CE} 5 V/div
Plate 6. NPN Transistor. 2N3904

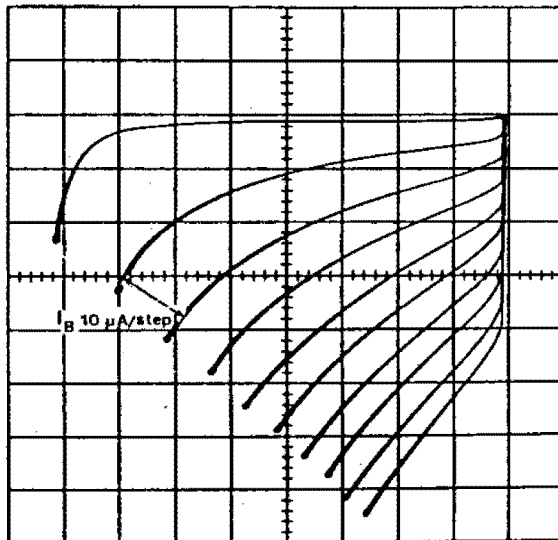

I_C 5 mA/div V_{CE} 5 V/div
Plate 7. PNP Transistor. 2N3702

2.7.1 Vce-Ic plot

The most useful characteristic which can be displayed is V_{CE} plotted against I_C for up to ten different values of I_B . The following parameters can be measured as detailed in the subsequent paragraphs.

1. $V_{(BR)CEO}$ Breakdown voltage, collector to emitter (base open-circuited).
2. $V_{CE0(SUS)}$ Collector to emitter (breakdown) sustaining voltage (base open-circuited).
3. $V_{(BR)CES}$ Breakdown voltage, collector to emitter (base shorted to emitter).
4. $V_{CES(SUS)}$ Collector to emitter (breakdown) sustaining voltage (base shorted to emitter).
5. h_{FE} Static value of the forward current transfer ratio (common emitter mode)
6. h_{fe} Small signal value of the short-circuit forward current transfer ratio (common emitter mode).
7. h_{oe} Small signal value of the open-circuit output admittance (common emitter mode).
8. V_{CEsat} Collector to emitter saturation voltage.
9. I_{CEO} Collector to emitter cut off current (base open-circuited).
10. I_{CES} Collector to emitter cut off current (base shorted to emitter).

2.7.1.1 $V_{(BR)CEO}$

Set controls as follows:—

1. PEAK WATTS to 0.1 W.
2. AC-DC to AC.
3. VCE-VBE to VCE.
4. STEP AMPLITUDE to O.C.
5. HORIZ VOLTS/DIV and CURRENT/DIV to appropriate ranges.
6. \pm to suit polarity of device.
7. Increase the COLLECTOR SUPPLY until breakdown occurs.
8. Read off the breakdown voltage on the horizontal scale.

NOTE: If the breakdown voltage or the collector-base capacity is very high and the required current range setting on the CURRENT/DIV is low, the current flowing through the collector-base capacitance may upset the measurement. To overcome this, set the AC-DC to DC.

2.7.1.2 $V_{CE0(SUS)}$ as 2.7.1.1 above with CURRENT/DIV set higher. To obtain sufficient current, it may be necessary to set the PEAK WATTS higher.

CAUTION. This setting may be higher than the maximum power dissipation of the device and care must be taken when increasing the COLLECTOR SUPPLY not to exceed the required value of collector current.

2.7.1.3 $V_{(BR)CES}$ as 2.7.1.1 above with STEP AMPLITUDE set to S.C.

2.7.1.4 $V_{CES(SUS)}$ as 2.7.1.2 above with STEP AMPLITUDE set to S.C.

2.7.1.5 h_{FE}

Set controls as follows:—

1. HORIZ VOLTS/DIV and CURRENT/DIV to the appropriate ranges.
2. Other controls as detailed in Table 1.
3. STEP AMPLITUDE and STEPS to obtain a suitable display.
4. OFFSET, so that the base line of the display is just at zero current. For a more accurate setting reduce the CURRENT/DIV by a factor of ten or increase the STEP AMPLITUDE by a factor of ten. With germanium transistors having an appreciable value of I_{CEO} , OFFSET should be set so that the first curve of the display is just the same as that obtained with STEP AMPLITUDE in the O.C. position. h_{FE} is then obtained by dividing the value of collector current by the value of base current required to give the required value of collector current.

NOTE: Better accuracy will be obtained if the largest possible number of base steps are used to obtain the required collector current.

2.7.1.6 h_{re}

Set controls as follows:—

1. HORIZ VOLTS/DIV and CURRENT/DIV to the appropriate ranges.
2. Other controls as detailed in Table 1.
3. STEP AMPLITUDE and STEPS to give curves spaced by approximately one division.
4. OFFSET to space curves equally above and below the required collector current and voltage. h_{re} is then ΔI_c divided by the value of one base current step.

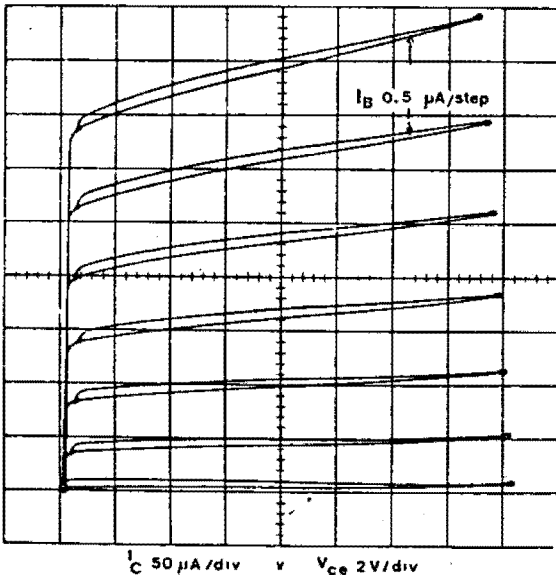

Plate 8. Effect of collector-base capacity. 2N3904

The display for the above measurements, 2.7.1.5 & 2.7.1.6, may be distorted by the effects of collector-base capacity when any of the following are used:—

- High collector voltages.
- Low collector currents.
- High h_{re} transistors.

Check by setting the number of base steps to an even number; the effect of the capacity is to make each curve into a loop and distort the knee of the characteristic. Obviate by setting AC-DC switch to DC. The display then becomes a series of dots which plot the characteristics as the COLLECTOR SUPPLY is rotated.

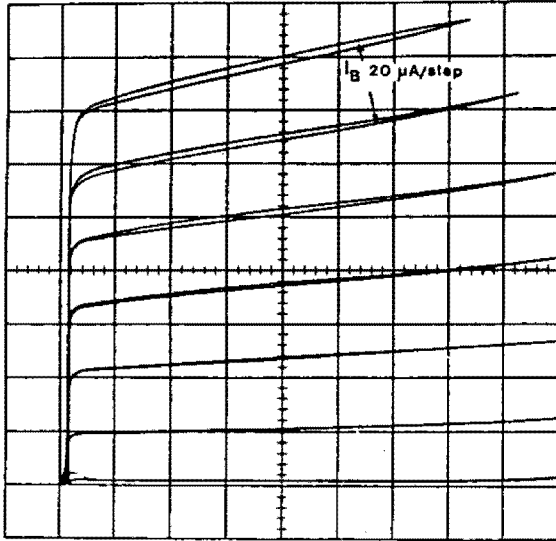

Plate 9. Heating effect in 2N3904

Another effect which can cause the curves to become loops is the heating of the device. This occurs when the power dissipation in the device is high and gets worse as the current increases. Again, to observe the loop, an even number of steps should be used.

2.7.1.7 h_{oe}

Set up VCE-IC display as 2.7.1.6 above. Adjust OFFSET so that a curve passes through the required value of collector current and voltage. h_{oe} is then obtained from the slope of the curve at that point.

2.7.1.8 V_{CEsat}

Reference Plate 10

Set up VCE-IC display as 2.7.1.5 above. Adjust STEPS to obtain the required base current. V_{CEsat} is then read off at the appropriate collector current.

2.7.1.9 V_{CE0} and I_{CES}

Set up VCE-IC displays as 2.7.1.1 for I_{CE0} & as 2.7.1.3 for I_{CES} , with CURRENT/DIV set lower. In most silicon transistors, capacity effects will predominate and it will be necessary to set AC-DC switch to DC.

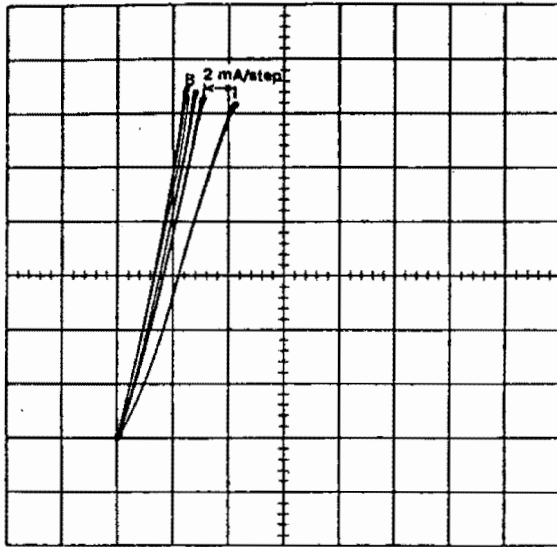

I_C 20 mA/div V_{CE} 0.1 V/div
Plate 10. I_{B} for 2N3904

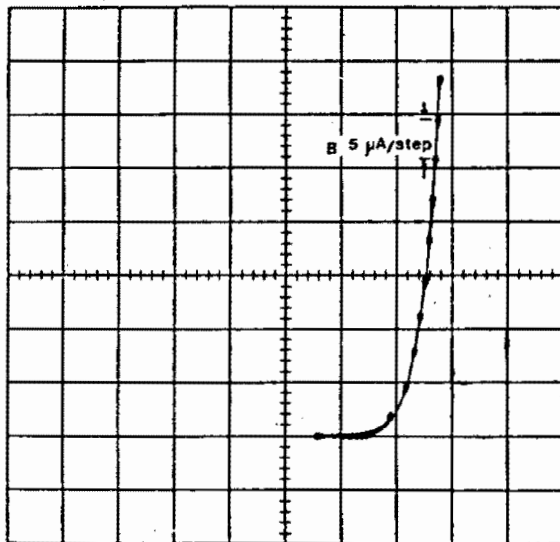

I_C 2 mA/div V_{BE} 0.1 V/div
Plate 11. NPN Transistor. 2N3904

2.7.2 V_{BE} - I_C plot

In the display, derived from V_{BE} against I_C , a dotted line appears. Each dot represents one base step and has a line above or below it extending to another dot on the zero current axis. The dots on the zero current axis should be ignored in all measurements. At low currents these dots can be removed by switching AC-DC to DC.

In order to establish the zero of the voltage scale, set STEP AMPLITUDE to S.C. As values of V_{BE} are usually below 1 V, the display is obtained on 0.1 V/DIV

horizontal scale. This means that the maximum collector voltage available will be 2 V, but this is normally sufficient to be above the knee of the collector characteristic.

The following parameters can be measured from the V_{BE} - I_C display, as detailed in subsequent paragraphs.

1. V_{BE} At any value of collector current I_C or base current I_B .
2. $V_{BE_{sat}}$ Base to emitter saturation voltage.
3. h_{ie} Small signal short circuit input impedance (common emitter mode).

2.7.2.1 V_{BE} and $V_{BE_{sat}}$

1. Set HORIZ VOLTS/DIV to 0.1.
2. Set CURRENT/DIV and STEP AMPLITUDE to appropriate ranges.
3. Set other controls as detailed in Table 1.
4. Turn COLLECTOR SUPPLY clockwise far enough so as not to restrict the maximum collector current. Any further increase in the COLLECTOR SUPPLY will reduce the definition of the dots by making them into short lines. For the best display, reduce SERIES RESISTOR to the lowest possible value by setting PEAK WATTS to 10 and SERIES RESISTOR to 0.

CAUTION. Care should be taken not to exceed the power dissipation of the device by keeping the collector supply as low as possible.

To obtain the correct base current, OFFSET should be set to bring the first dot to the start of the collector current. A more accurate setting of the above can be obtained by reducing the CURRENT/DIV by a factor of 10.

The base current value at any dot can then be found by counting the number of dots after the first one and multiplying by the STEP AMPLITUDE setting. The collector current values can be read directly from the vertical deflection multiplied by the CURRENT/DIV switch setting. V_{BE} and $V_{BE_{sat}}$ at the appropriate base or collector current is the horizontal distance from zero base volts.

2.7.2.2 h_{ie}

1. Set controls as detailed in 2.7.2.1.
2. Adjust OFFSET to obtain two dots equally spaced about the required collector current.

ΔV_{BE} for the two selected dots is then measured. The measurement can be made easier by increasing the CURRENT/DIV setting to reduce the vertical separation of the required two dots. h_{ie} is then ΔV_{BE} divided by the STEP AMPLITUDE setting.

2.7.3 Other parameters

$V_{(BR)CBO}$, $V_{(BR)EBO}$, I_{CBO} , I_{EBO} , C_{cb} and C_{cb} of bipolar transistors can also be measured or compared in the same manner as detailed in 2.6. Diodes, with the appropriate pair of leads plugged into the C and E sockets, the third lead being open circuited.

Common base characteristics can be displayed but are of limited usefulness as no important measurements

can be made which could not be more accurately determined from the common emitter characteristics.

For convenience transistors of EBC configuration may be plugged into the FET sockets when displaying common base characteristics. The collector is connected to D, the base to S and the emitter to G.

Conversely transistors of ECB configuration may be plugged into the normal transistor sockets for common base characteristics or the FET sockets for common emitter characteristics. In all cases the collector of the device must be connected to the collector or drain socket.

The values of h_{ib} , h_{rb} and h_{ob} are calculated by dividing h_{ie} , h_{re} and h_{oe} respectively by $1 + h_{fe}$.

2.8 FIELD EFFECT TRANSISTORS (FET's)

The most useful characteristic which can be displayed is V_{DS} plotted against I_D for up to ten different values of V_{GS} . The following parameters can be measured as detailed in the subsequent paragraphs.

1. $V_{(BR)DSO}$ Breakdown voltage, drain to source with gate open-circuited.
2. $V_{(BR)DSS}$ Breakdown voltage, drain to source with gate shorted to source.
3. I_{DSS} Drain current with gate shorted to source.
4. g_m or y_{fs} Mutual conductance or forward transconductance (common source).
5. y_{os} Output admittance (common source).
6. V_{GS} Gate to source voltage for any value of drain current I_D .

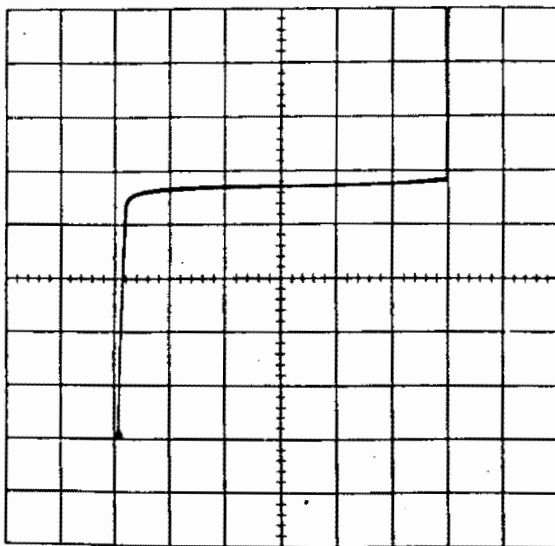

Plate 12. $V_{(BR)DSO}$ & I_{DSS} . N-channel FET. 2N4220

2.8.1 $V_{(BR)DSO}$ and $V_{(BR)DSS}$

These cannot normally be measured without exceeding the power dissipation of the device unless they occur at very low voltage or the device has a low I_{DSS} . These can normally be taken to equal $V_{(BR)DSO}$ and $V_{(BR)DSS}$ respectively.

2.8.2 I_{DSS}

Set controls as follows:—

1. STEP AMPLITUDE to S.C.
2. HORIZ VOLTS/DIV and CURRENT/DIV to appropriate ranges. I_{DSS} , at required drain voltage, is read from the vertical scale.

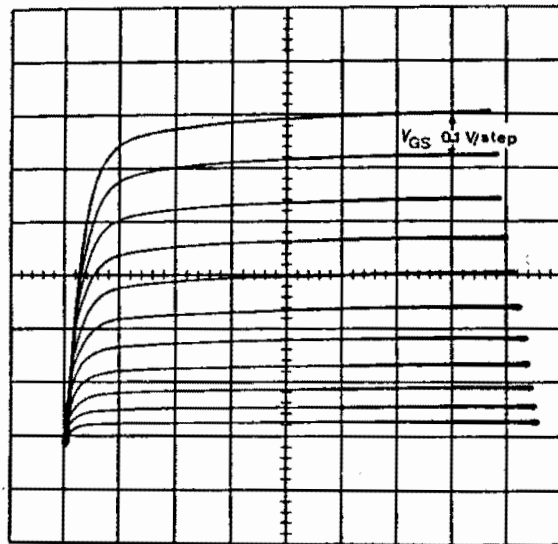

Plate 13. N-channel FET. 2N4338

2.8.3 g_m or y_{fs}

Set controls as follows:—

1. HORIZ VOLTS/DIV and CURRENT/DIV to appropriate ranges.
2. Other controls as detailed in Table 1.
3. STEP AMPLITUDE and STEPS to obtain a display with curves spaced by 1 div. approx. at the required drain current.
4. OFFSET to space the curves equally above and below the required drain current and voltage, g_m is then ΔI_D divided by the value of one gate voltage step.

2.8.4 y_{os}

Set controls as detailed in 2.8.3 above with OFFSET adjusted so that a curve passes through the required value of drain current and voltage. The slope of the curve is then the required value.

2.8.5 V_{GS} may be measured by two methods.

METHOD 1.

1. Set controls as detailed in Table 1.
2. Set HORIZ VOLTS/DIV and CURRENT/DIV to appropriate ranges.
3. Turn STEPS fully anti-clockwise.
4. Set STEP AMPLITUDE to 2 V.
5. Adjust OFFSET to the point at which it just begins to reduce the current.
6. Set STEP AMPLITUDE and STEPS to give as many steps as possible between I_{DSS} and the required current.

Multiply the exact number of steps including fractions, if any, by the STEP AMPLITUDE to establish the value of V_{GS} .

METHOD 2.

V_{GS} plotted against I_D .

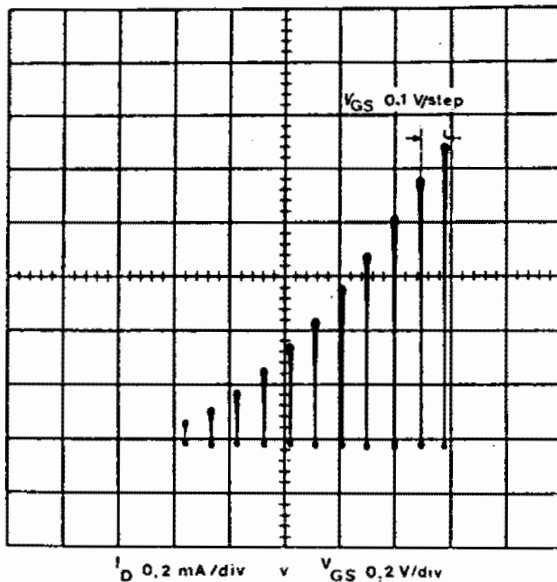

Set VCE/VBE to VBE. The curve appears as a dotted line, each dot representing one gate step with a vertical line extending to zero current above or below it. At low currents these may be removed by switching AC-DC to DC. From this display, V_{GS} is determined at any value of I_D .

Capacity effects do not occur in FET's measurements but loops due to heating effects do occur exactly as in bipolar transistors (2.7.1.6).

2.8.6 Other parameters, which can be measured or compared by using two terminals of the device, are $V_{(BR)DGO}$ and $V_{(BR)SGO}$. These in practice are identical and the same as $V_{(BR)GSS}$. C_{GSS} and C_{GDS} are also both the same as are C_{GSO} and C_{GDO} . To measure these parameters use the gate and source or drain terminals and measure as detailed in 2.8.

I_{GSS} , the reverse gate current, is usually too small to measure and if any current can be measured this would indicate a reject FET. Some idea of the reverse currents can be obtained by measuring the forward voltage required to obtain 5 nA. For a satisfactory FET, this should be between 0.3 and 0.4 V. Lower voltages indicate high reverse currents. Common gate characteristics cannot easily be displayed and have limited usefulness.

As for bipolar transistors, different lead configurations can conveniently be plugged into the transistor sockets. In all cases the gate lead must be plugged into the gate or base socket.

2.8.7 V_P , the pinch off voltage, is very difficult to measure and is more easily calculated from the relationship

$$V_P = 2 \frac{I_{DSS}}{g_{m0}}$$

where g_{m0} is the value of g_m when $V_{GS} = 0$.

A more accurate value may be achieved by plotting a graph of $\frac{I_D}{g_m}$ against V_{GS} . This should be a straight line, which intercepts the V_{GS} axis at V_P .

2.9 THYRISTORS (SCR's), TRIACS and other PNP DEVICES

The following parameters are measured as detailed in the subsequent paragraphs:—

1. The forward breakdown voltage.
2. The reverse breakdown voltage.
3. The voltage drop at various currents in the on-condition.
4. The gate turn-on voltage and current requirements for various values of anode-cathode voltage.
5. The holding current I_H . This measurement cannot be made on certain devices as it is destructive.

2.9.1 Forward breakdown voltage

As detailed in 2.9.2, below and refer to Plate 15 overleaf

2.9.2 Reverse breakdown voltage

Reference Plate 16, overleaf

1. Connect cathode, anode and gate terminals of the device to the E, C and B terminals respectively.
2. Set HORIZ VOLTS/DIV and CURRENT/DIV to appropriate ranges.
3. Set PEAK WATTS to 0.1.
4. Set STEP AMPLITUDE to S.C.
5. Set AC-DC to AC.
6. Set \pm to + for forward breakdown or - for reverse breakdown voltage.

7. Increase the COLLECTOR SUPPLY until breakdown occurs.
8. Read off the breakdown voltage on the horizontal scale.

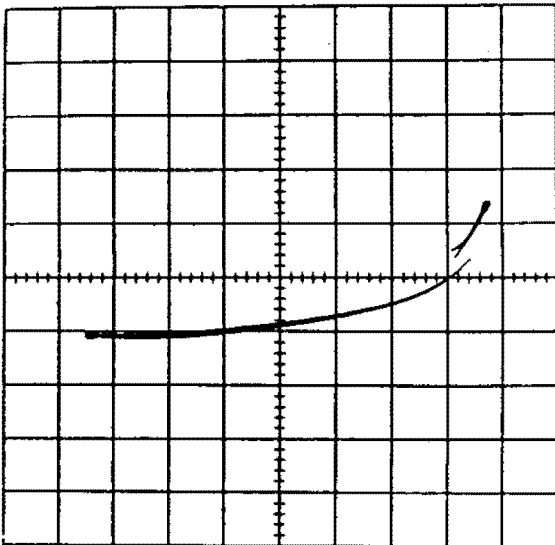

I_F 200 μ A/div V_F 100V/div

Plate 15. Thyristor Forward Breakdown. 2N4441

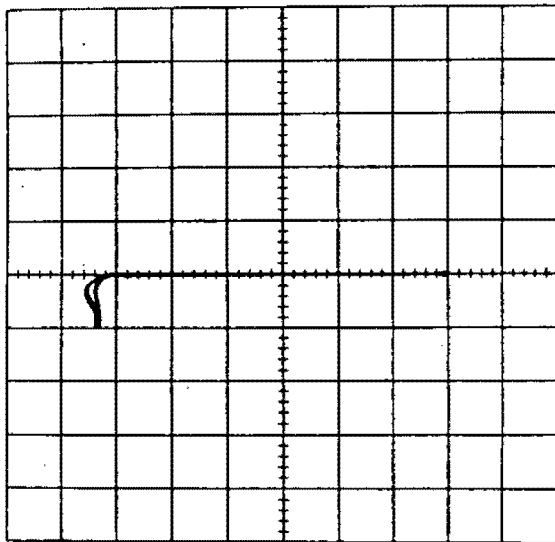

I_R 100 μ A/div V_R 20V/div

Plate 16. Thyristor, Reverse breakdown

2.9.3 Voltage drop in the On-condition

Reference Plate 17

1. Set HORIZ VOLTS/DIV to 0.2.
2. Set \pm to +.
3. Set AC-DC to AC.

4. Set POLARITY to +.
5. Set CURRENT/DIV to appropriate range.
6. Turn COLLECTOR SUPPLY fully clockwise.
7. Set VCE/VBE to VBE.
8. Adjust STEPS to obtain a single step.
9. Reset VCE/VBE to VCE.
10. Increase the STEP AMPLITUDE until the device is fired.

NOTE: If necessary, reduce SERIES RESISTOR or increase PEAK WATTS to obtain required current.

11. Read off the voltage drop on the horizontal scale.

NOTE: If sufficient gate current is not available increase the number of steps.

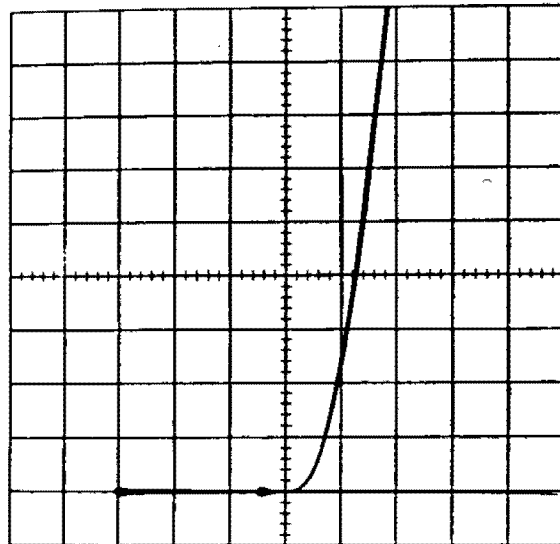

I_F 0.2A/div V_F 0.2V/div

Plate 17. Thyristor On-condition. 2N4441

2.9.4 Gate turn-on voltage

1. Set HORIZ VOLTS/DIV and CURRENT/DIV to appropriate ranges.
2. Set \pm to +.
3. Set VCE/VBE to VCE.
4. Set AC-DC to AC.
5. Set POLARITY to +.
6. Turn STEPS fully clockwise.
7. Turn OFFSET fully anti-clockwise.
8. Set COLLECTOR SUPPLY to give correct anode voltage.
9. Increase STEP AMPLITUDE until the device is triggered, using current steps.
10. Reduce the number of steps to the minimum to maintain the On-condition.

11. Turn OFFSET clockwise until the On-Condition is just maintained.
12. Set VCE/VBE to VBE.
13. Set HORIZ VOLTS/DIV to 0.2.
14. Switch STEP AMPLITUDE to S.C. and note the zero volt point.
15. Reset STEP AMPLITUDE to previous setting and read off gate turn-on voltage on the horizontal scale.

2.9.5 Gate turn-on-current

Repeat 1 through 12 above.

13. Switch DEVICE SELECT to OFF.
14. Set STEP AMPLITUDE to S.C. Note the zero voltage point.
15. Set HORIZ VOLTS/DIV to 2V.
16. Set STEP AMPLITUDE. Note total voltage swing to the last step.

$$\frac{\text{Gate turn on current}}{\text{Total voltage swing}} = \frac{\text{original STEP AMPLITUDE}}{2} \times \text{CURRENT SETTING}$$

2.9.6 The holding current I_H

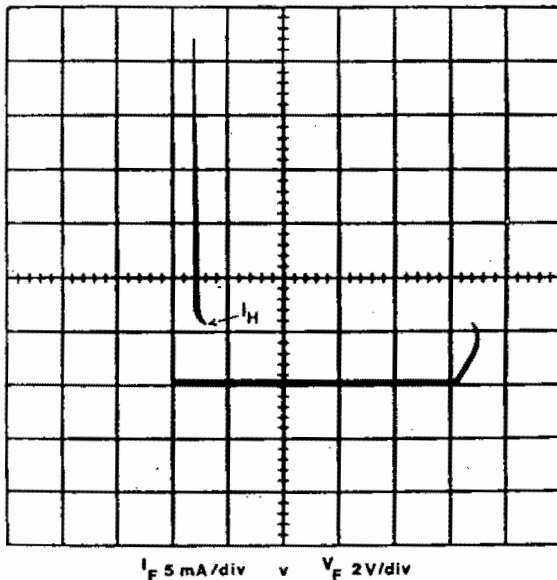

Plate 18. Thyristor Holding current. 2N4441

CAUTION. This test can destroy some SCRs and Triacs if the breakdown does not occur over the whole junction area. To measure the holding current of these devices, a zener diode of less voltage than the forward breakdown voltage value should be connected between anode and gate terminals.

1. Set HORIZ VOLTS/DIV to appropriate range.
2. Set CURRENT/DIV to a value higher than set in 2.9.1.
3. Set PEAK WATTS to 0.1.
4. Set STEP AMPLITUDE to O.C.
5. Set AC-DC to AC.
6. Set \pm to +.
7. Increase the COLLECTOR SUPPLY until the device switches to the On-condition.

The holding current I_H , when the device switches from the On-condition to the Off-condition, can be read off the vertical scale.

2.10 UNIJUNCTION TRANSISTORS

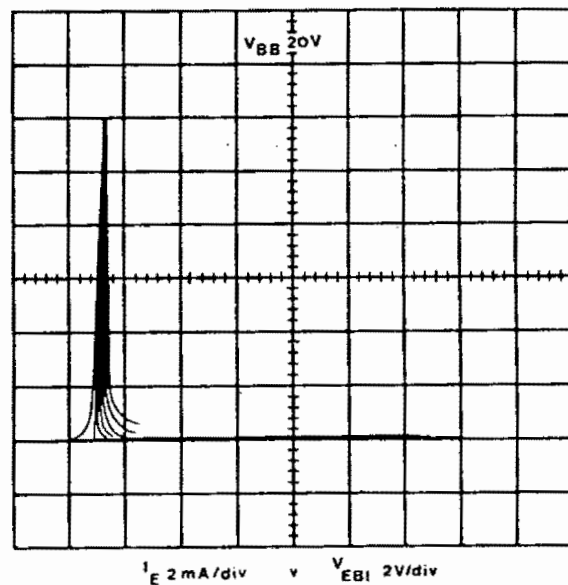

Plate 19. Unijunction Transistor. 2N4871

The following parameters can be measured:—

1. Interbase resistance r_{BB} .
2. Intrinsic standoff ratio η
3. Peak point voltage V_P .
4. Valley point voltage V_V and current V_V .
5. Emitter saturation voltage $V_{EB1(\text{sat})}$.

2.10.1 Interbase resistance r_{bb}

1. Connect base 1 (B1) to socket E.
base 2 (B2) to socket C.
2. Set HORIZ VOLTS/DIV and CURRENT/DIV to appropriate ranges.
3. Set PEAK POWER to 0.1 W.
4. Set STEP AMPLITUDE to O.C.
5. Set POLARITY to +.
6. Set AC-DC to AC.
7. Set \pm to +.
8. Set VCE-VBE to VCE.
9. Set COLLECTOR SUPPLY to the required voltage V.
10. Read off current I on the vertical scale.

$$r_{bb} = \frac{V}{I}$$

2.10.2 Intrinsic standoff ratio η

1. Connect base 1 (B1) to socket E.
base 2 (B2) to socket B.
emitter (E) to socket C.
2. Set HORIZ VOLTS/DIV to the appropriate range.
3. Turn COLLECTOR SUPPLY fully anticlockwise.
4. Set PEAK POWER to 0.1 W.
5. Set \pm to +.
6. Set AC-DC to AC.
7. Set VCE-VBE to VBE.
8. Set SERIES RESISTOR to 25 k.

9. Set CURRENT/DIV to 1 mA.
10. Set STEP AMPLITUDE to S.C.
11. Set POLARITY to +.
12. Note position of the spot to establish zero interbase voltage.
13. Set STEP AMPLITUDE to 2 V.
14. Adjusting OFFSET and STEPS (even number of steps should be used) obtain correct η .
15. Set VCE-VBE to VCE.
16. Set CURRENT/DIV to 10 μ A.
17. Increase COLLECTOR SUPPLY until V_P is reached.
18. Note the value of voltage V_P and current I_P .
19. Set STEP AMPLITUDE to S.C.
20. Note the value of voltage V_D at I_P , Op. 18 above.

$$\eta = \frac{V_P - V_D}{V_{BB}}$$

A2.10.3 Peak point voltage V_P

This is determined from 2.10.2, Op. 18 above.

2.10.4 Valley point voltage V_V and current I_V

As 2.10.2 above, setting CURRENT/DIV and SERIES RESISTOR to the appropriate ranges to obtain sufficient current.

2.10.5 Emitter saturation voltage $V_{EB1(sat)}$

As 2.10.2 above, setting CURRENT/DIV to 10 mA and adjusting SERIES RESISTOR, PEAK WATTS and COLLECTOR SUPPLY to give an emitter current of 50 mA.

SECTION 3

CIRCUIT DESCRIPTIONS

3.1 BLOCK DIAGRAM

3.1.1 This chapter will assist the reader to comprehend the circuitry of the CT71. The block diagram below shows the interfaces of the various circuits; these will be dealt with later.

3.1.2 The horizontal and vertical amplifiers (Figs. 1 & 2) measure voltage between either collector/emitter or base/emitter sockets and collector current respectively which are amplified and then applied to the deflection plates of the CRT (Fig. 5).

3.1.3 The step generator (Fig. 3) produces positive or negative steps of current or voltage, these are applied to the base socket connected to the device.

3.1.4 The collector supply circuit (Fig. 4) produces full-wave rectified sine waves of either polarity between 0—1 kV; these are set by various controls and applied to the collector socket connected to the device.

3.2 HORIZONTAL AMPLIFIER

This circuit, reference Figure 1, is a three-stage amplifier.

3.2.1 The 1st stage, a differential amplifier, comprises TR101 and TR102.

The base of TR101 is provided with current from the +12 V supply via R129, R131, R132 and R133 in series. R131 is adjusted to provide the correct base current. R132 and R139 set the input impedances. The horizontal shift and balancing voltages set by R128 and R127 respectively are derived from the +6 V and -6 V stabilized supplies. D101 and D102 in the emitters increase the input voltage swing which the amplifier can handle without distortion. The sensitivity of the amplifier is set by R135 which varies the current in the first stage.

3.2.2 The 2nd stage, TR103 and TR104, is a shunt feedback amplifier. R143 in the emitters of this stage is adjusted to give the correct mean X plate potential.

3.2.3 In the 3rd stage, TR105 and TR106, a thermistor TH101 in the emitter circuit compensates for the variation in the gain of the 1st stage due to temperature.

3.2.4 The input voltage to TR101 is obtained from either the collector or base of the device under test via S101 DEVICE SELECT and S102 VCE-VBE; it is attenuated by a resistive network selected by S401Bf and Ab. The input voltage to TR102 is obtained directly from the emitter of the device under test on the 10 μ A to 0.2 A positions of the CURRENT/DIV switch or via TR601 and TR602 on the 5 nA to 5 μ A positions of

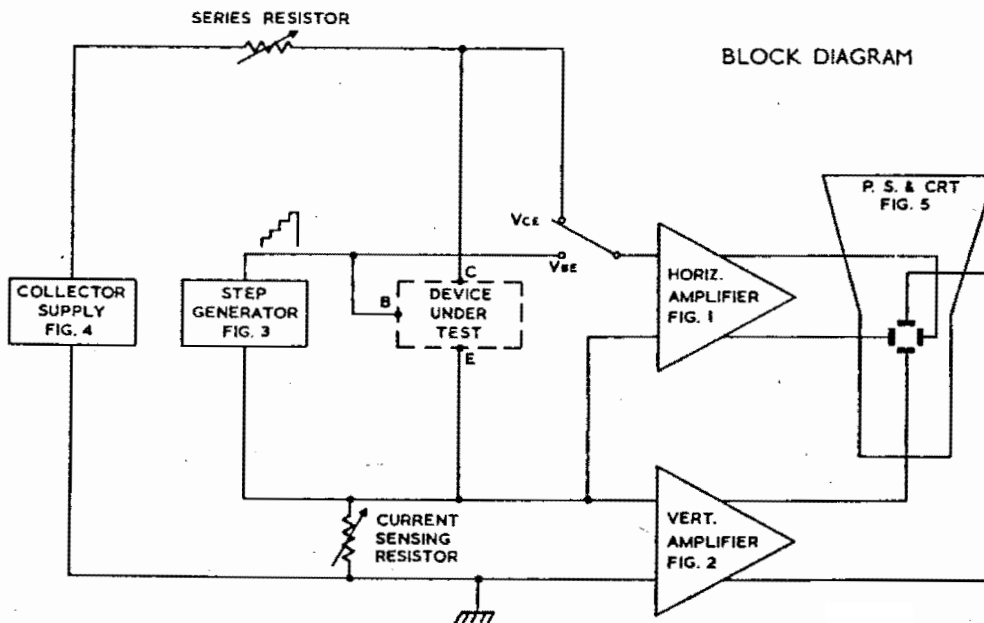

the CURRENT/DIV switch. It is attenuated by a resistive network selected by S401Af by the same amount as the input to TR101.

3.3 VERTICAL AMPLIFIER

This circuit, reference Figure 2, is a three-stage amplifier.

3.3.1 The 1st stage comprises TR601 and TR603. The base of TR601 is provided with current from the +12 V supply via R631, R632 and R633 in series. R632 is adjusted to supply the correct base current; R635 sets the input impedance. The vertical shift and balancing voltages set by R645 and R642 respectively are derived from the +6 V and -6 V stabilized supplies. TR602, an emitter follower, reduces the loading of the horizontal amplifier on the emitter output of this stage. R637 sets the potential of the emitter to earth. D601, D602, D603 and D604 together with fuse FS601 protect the circuit against large overloads.

3.3.2 TR604 and TR605 make up the 2nd stage, a shunt feedback amplifier. The mean plate potential of the Y plates is adjusted by R650 and the input sensitivity is set to 1mV/div by R652.

3.3.3 In the 3rd stage TR606 and TR607, a thermistor TH601 in the emitter circuit compensates for the variation in the gain of the 1st stage due to temperature.

3.3.4 The emitter current from the device under test is fed via FS601 through sensing resistors R601-R625, selected by S601Af, to develop a voltage. This is fed either directly or via a 100:1 attenuator R626 and R627, through the above amplifier to the Y plates of the CRT. The vertical deflection factor of the display is controlled by S601.

3.4 STEP GENERATOR

3.4.1 In this circuit, reference Figure 3, 30-0-30 V from the secondary of T451 is applied to the full-wave rectifiers D7 and D10. The resulting half sinusoids are phase shifted by R2, C1 and R10, then applied to the base of TR1; this with TR2 forms a Schmitt trigger circuit. The potentiometer R9 (Phase) coupling the emitters of the trigger circuit, sets the degree of backlash and C3 acts as a speed-up capacitor. R3, R4 and R8 provide the D.C. component of the base current and C4 provides the A.C. component of the base current.

3.4.2 The output from each collector of the trigger circuit, which is twice the supply frequency, is fed via C5 or C7 to diodes D1 and D2 respectively. The resulting spikes, which are four times the supply frequency, are adjusted to equal width by R19 and then applied to the base of TR3, this with TR10 forms a long-tailed pair. R24 adjusts the bias on the long-tailed pair and therefore the conduction time of TR10.

3.4.3 The collector current of TR10 charges the capacitor C8 each time a pulse occurs, by a fixed voltage. When this voltage approaches the base voltage of TR4, set by the control R46, it starts to conduct. The regeneration around the loop of TR4 and TR5 causes both to conduct and bottom, thus discharging C8 rapidly. TR4 and TR5 cut off when the current falls to a value where the loop gain is less than 1 and the cycle is repeated. R28 varies the supply voltage to the step generator by up to 4V and enables the steps to be offset by ± 1 step.

3.4.4 The voltage staircase waveform is transmitted to the polarity switch S2 by three emitter follower stages TR6-TR8 in cascade.

3.4.5 The 2 V base steps are attenuated by a resistive divider consisting of R26, R31, R35, R37, R43 and R44, to 1 V, 0.5 V, 0.2 V and 0.1 V, the output being selected by S1Af. The base current steps are obtained by switching appropriate resistors in series with the 2 V step output by means of S1Af. The base step generator is disconnected by S601C in the 5 nA — 5 μ A positions of the CURRENT/DIV switch.

3.4.6 The power for the step generator is provided by the voltage stabilizing circuit, comprising TR9 and TR11, potential divider R51, R52, R53 and D6, a zener diode. The emitter of TR9 is held at a constant potential by D3, which is biased to the breakdown state by R54, with the base being fed part of the output voltage from the potential divider. The error voltage, amplified by TR9 and TR11, is fed back to the output to reduce the variations. C12 increases the gain at ripple frequency.

3.4.7 The input to the stabilizing circuit is provided by D8 and D9, full-wave rectifiers and C13 a reservoir capacitor.

3.5 COLLECTOR SUPPLY

3.5.1 A 53 V primary tap on T451 (Fig. 5) provides, via Variac T401 (Fig. 4) and FS401, a supply to the primary of T402, from which secondary voltages selected by S401cb, Df & Db are applied to rectifiers D401-D404. When S401 is set between 0.1 and 0.5 Volts/Div; D401 and D402 produce a negative full-wave rectified output, and D403 and D404 a positive full-wave rectified output. On all other ranges, D401-D404 are connected in a bridge circuit. R415 and R416 reduce the effect of stray capacities in the transformer T402 which give unequal half cycles at the output.

3.5.2 The polarity switch S402 selects either the positive-going or the negative-going full-wave rectified sine waves by reversing the output connections to the rectifiers.

3.5.3 Switch S405 selects either AC or DC. When S405 is set to DC, capacitors C401-C404 in combination with C406 or C407 (dependent on the position of switch S401) act as reservoir capacitors. R406, R409 and R417 discharge these capacitors.

3.5.4 The series resistors R401-R414 in series with the collector sweep output are selected by interconnected switches S401 and S403 and limit the peak power to 0.1, 0.5, 2 and 10 W depending on the setting of S404.

3.6 POWER SUPPLY

3.6.1 The line side of the A.C. supply is applied to the two primary windings of the power transformer (Fig. 5) via FS451, S451 and the voltage selector panel. This connects the two primary windings in series for operating from 200/250 V or in parallel from 100/125 V. A 53 V primary tap provides a supply to collector supply circuit (Fig. 4).

3.6.2 The secondary windings of T451 provide the following:—

- (1) 13.0-13.4 V A.C. to drive the POWER ON light LP451 and the graticule lights LP452 & LP453 controlled by R451.
- (2) 6.3 V floated at about -1.25 kV to the CRT heater.
- (3) 30.0-30 V A.C. to the step generator (Fig. 3).
- (4) 450 V A.C., via voltage doubler D453, D454, C456, C457 & C458, produces $+1.25$ kV D.C. for CRT PDA helix and -1.25 kV for the electron gun via voltage doubler D457, D458, D459, D461, C454, C455 and C462-C465.

(5) 47 V A.C., via voltage doubler D451, D452, C452 and C453, produces $+112$ V supply; R452 and C459 filter the supply.

(6) 13 V A.C., via full-wave rectifier circuit D455, D456, R453 and C461, produces -12 V supply; R461 and C466 filter the supply. The -6 V stabilized line is provided by the current limiting resistor R462 and the zener D463.

(7) The $+112$ V supply line also provides $+12$ V semi-stabilized and $+6$ V stabilized supply lines. The thermistor TH451 makes the temperature coefficient of the $+12$ V supply line negative to supply the base currents for TR101 & TR601.

3.7 CATHODE RAY TUBE

The CRT and its related controls use the following power supplies:—

- (1) $+1.25$ kV for PDA helix.
- (2) $+112$ V for the astigmatism control R302 which varies the A3 potential of the CRT.
- (3) -1.25 kV reduced by zener diode D301 to provide -1150 V cathode voltage. The FOCUS R304 and the INTENSITY R306 controls on the front panel vary the voltages on A 2 and the grid of the CRT. The current through the trace rotation coil is adjusted by R454 on the rear of the instrument.

SECTION 4

MAINTENANCE AND CALIBRATION

4.1 GENERAL

4.1.1 The entire solid-state design of the instrument should render frequent re-adjustment of the internal preset controls unnecessary; however, to ensure the maintenance of full measurement accuracy, it is desirable to make an occasional check on the vertical and horizontal accuracy of the instrument. The internally generated 10 dot trace may conveniently be used for these checks by the following procedure:— For accuracy, the 2nd and 9th dot of the trace should coincide with the 2nd and 9th division.

4.1.2 Horizontal accuracy

1. Set HORIZ VOLTS/DIV to 2.
2. Set VCE/VBE to VBE.
3. Set STEP AMPLITUDE to 2 V.
4. Adjust STEPS to give a 10 dot trace.
5. Adjust the horizontal SET SEN to rectify any inaccuracy.

4.1.3 Vertical accuracy

1. Set VCE/VBE to VCE.
2. Set COLLECTOR SUPPLY fully anti-clockwise.
3. Set HORIZ VOLTS/DIV to 10.
4. Set CURRENT/DIV to 10 μ A.
5. Set STEP AMPLITUDE to 0.1 V.
6. Short terminal B to EARTH.
7. Set DEVICE SELECT for item 6 above.
8. Adjust STEPS to give a 10 dot trace.
9. Adjust vertical SET SEN to rectify any inaccuracy.

4.2 FAULT DIAGNOSIS

4.2.1 Before it is assumed that a fault condition exists, control settings should be verified with reference to the Pre-operational checks para. 2.2. The table, Appendix A of this chapter will assist in fault diagnosis.

4.2.2 Should a more complete calibration be required, such as in the event of transistor replacement, reference should be made to the appropriate procedure in the calibration part of this section, 4.4.

4.3 MECHANICAL

4.3.1 ACCESS TO INTERIOR

The cabinet sides are removed as follows:—

1. Disconnect the power supply.

2. Loosen the two handle-clamp securing screws.
3. Ease the top of each side outwards.
4. Unhook the bottom of each side from the locating slots in the chassis base and remove the two sides.

4.3.2 CRT REMOVAL

1. Remove cabinet side as detailed above.
2. Remove the rear cover (four screws).
3. Unplug the trace rotation plug and the 12-pin CRT base socket.
4. Remove the three screws securing the gun shield to the chassis.
5. Slide the tube assembly rearwards until the front of the CRT is disengaged from the support cushions.
6. Unplug the PDA connector.

CAUTION. Ensure the residual charge is fully dissipated by earthing the PDA cap.

7. Withdraw the tube assembly carefully.

4.3.3 CRT FITTING

Reverse the order detailed above, 4.3.2. Ensure that the front vertical side of the tube is parallel to that of the chassis.

4.4 CALIBRATION

The following procedure enables a full calibration of the instrument to be accomplished and the following equipment is required. If any adjustment or adjustments are made in isolation, regard should be paid to the risk of interaction with other adjustments and to control settings.

1. Variac.
2. Calibrator Telequipment C.3 or equivalent.
3. Avometer.
4. Oscilloscope Telequipment D1010 or equivalent.
5. Signal Generator.
6. Resistor, 200 k, 0.1%.
7. Screwdriver.

IMPORTANT. Never adjust the potentiometer, R52, controlling the voltage of the stabilized line unless it is intended to carry out a complete calibration of the instrument.

4.4.1 PRELIMINARY PROCEDURE

1. With the instrument disconnected from the supply, remove the cabinet sides as detailed in 4.3.1.
2. Set all internal presets to mid-position.
3. Insert the voltage selector plug in the rear panel with the arrow indicating the normal voltage of the local A.C. supply or the nearest value to it.
4. Connect the power cable to a Variac.

The cores of the cable are colour-coded as follows:—

Line	Neutral	Earth (Chassis)
Brown	Blue	Green/Yellow

Connect Variac to the supply and switch on supply.

5. Adjust the Variac to give the same voltage as that indicated by the voltage selector plug.

4.4.2 VERTICAL AMPLIFIER

1. Connect the collectors of TR105, TR106 together to short the X plates.
2. Turn the Vert Cur Bal R632 fully clockwise.
3. Set CURRENT/DIV to 0.2 A.
4. Set POSITION midway.
5. Adjust Y Shift Bal R642 to centre the spot on the tube.

NOTE: CRT controls may have to be adjusted for the best spot.

6. Remove TR606 and TR607.
7. Connect collector and emitter of TR607.
8. Measure the voltage between +112 V line and TR607 collector
9. Note the voltage and reference V1.
10. Remove connexion ref. 4.4.2.7 above).
11. Fit TR606 and TR607.
12. Measure the voltage across R659 note voltage and reference V2.
13. Measure the voltage across R655 note voltage and reference V3.
14. Adjust Y Plate Pot R650 so that

$$\frac{V2+V3}{2} = \frac{V1}{2} - 2 \text{ V.}$$
15. Repeat 5 and 14 until spot is central and the condition in 14 is met.
16. Set CURRENT/DIV to 5 nA and re-centre the spot using Vert Cur Bal R632.

17. Apply the calibrator output to the emitter (E) socket and set to 5 mV at 1 kHz.
18. Adjust SET SEN R652 to obtain a vertical deflection of 5 divisions.
19. Connect a 200 k, 0.1% resistor between calibrator output and emitter (E) socket, and set calibrator to 10 mV at 1 kHz. Adjust Vert Input Res R635 to obtain a vertical deflection of 5 divisions.
20. Set the CURRENT/DIV to 10 μ A.
21. Remove the resistor (4.4.2.10), reconnect calibrator to the emitter (E) socket and set to 500 mV at 1 kHz. Check that the vertical deflection is 4.95 divisions; if not, adjust SET SEN R652 to halve the error.
22. Remove the short 4.4.2.1.

4.4.3 HORIZONTAL AMPLIFIER

1. Turn Horiz V Bal R131 fully clockwise.
2. Set HORIZ VOLTS/DIV to 10V, SERIES RESISTOR to 25 k and PEAK WATTS to 0.1 W.
3. Turn the COLLECTOR SUPPLY control fully anti-clockwise. Set AC-DC to AC and \pm to +.
4. Set POSITION midway.
5. Adjust X Shift Bal R127 to centre the spot on the tube.
6. Remove TR105 and TR106.
7. Connect collector and emitter of TR106.
8. Measure the voltage between +112 V line and TR106 collector.
9. Note the voltage and reference V1.
10. Remove connexion (ref. 4.4.2.7 above).
11. Fit TR105 and TR106.
12. Measure the voltage across R145 note voltage and reference V2.
13. Measure the voltage across R149 note voltage and reference V3.
14. Adjust Y Plate Pot 143 so that

$$\frac{V2+V3}{2} = \frac{V1}{2} - 2 \text{ V.}$$
15. Repeat 5 and 14 until spot is central and the condition in 14 is met.
16. Set the CURRENT/DIV to 0.2 A.
17. Set the HORIZ VOLTS/DIV to 5 V.
18. Set the STEP AMPLITUDE to O.C. and POLARITY to +.
19. Set VCE-VBE to VBE.
20. Connect the Calibrator to either of the two base (B) sockets and set to 25 V at 1 kHz.

21. Select the base socket using DEVICE SELECT.
22. Adjust SET SEN control R135 to obtain a deflection of 5 divisions along the horizontal axis.
23. Set DEVICE SELECT to OFF and repeat 5 & 14 until both conditions are satisfied.
24. Repeat 21, 22 & 23 until spot is central and a 5 div horizontal deflection is achieved.
25. Set calibrator to 500 mV. Set the HORIZ VOLTS/DIV to 0.1 and adjust X1 Input Res R132 to obtain a horizontal deflection of 5 divisions. If this is not obtainable turn R132 fully clockwise.
26. Repeat 20 to 25.
27. Set calibrator to 10 V and HORIZ VOLTS/DIV to 2 V. Reset SET SEN R135 to give exactly 5 divisions horizontal deflection.
28. Set the DEVICE SELECT to OFF. Disconnect the calibrator.
29. Set the HORIZ VOLTS/DIV to 10 V. Set the POSITION to centre the spot.
30. Set the HORIZ VOLTS/DIV to 0.1 V and adjust Horiz V Bal R131 to centre the spot.
31. Repeat 29 & 30 until spot is central on both 10 V and 0.1 V positions.
32. Set HORIZ VOLTS/DIV to 0.1 and centre the spot. Set the CURRENT/DIV switch to 5 nA and re-centre the spot by adjusting Horiz Cur Bal R637.
33. Connect collector (C) and emitter (E) sockets together and select these sockets using DEVICE SELECT.
34. Set VCE-VBE to VCE, HORIZ VOLTS/DIV to 0.2, CURRENT/DIV to 10 μ A and short the collectors of TR105-106 together.
35. Turn the COLLECTOR SUPPLY control clockwise to obtain 10 divisions deflection along the vertical axis and set Trace Rotation control R454 to obtain a vertical line.
36. Remove the short (4.4.3.23) and adjust Common Mode Rejection R628 to obtain a vertical line.
37. Set the HORIZ VOLTS/DIV switch to 0.1 V. Adjust X2 Input Res R139 for a vertical line.
38. Repeat 36 & 37 until a vertical line is obtained on both 0.1 and 0.2 V positions.

4.4.4 STEP GENERATOR

1. Turn STEPS R46 and R52 fully anti-clockwise.
2. Connect D.C. voltmeter, across C11 and adjust R52 to obtain a reading of 30 V on the voltmeter. Disconnect the voltmeter.
3. Set HORIZ VOLTS/DIV switch to 10 V and STEP AMPLITUDE switch to 2 V.
4. Set the following controls to:—

±	+
POLARITY	+

5. Connect double beam oscilloscope, set to 20 V/div & 0.5 V/div to the C and B sockets respectively.
6. Select the appropriate sockets using DEVICE SELECT and check the collector and base waveforms.
7. Set the TIME/DIV to 1 ms and trigger the scope with base waveform which should be adjusted to approximately 1 div amplitude with OFFSET. Adjust timebase VARIABLE control if necessary to obtain a display where the rectified half sinewaves overlap.
8. Adjust Symmetry R3 so that the two pulses displayed about 5 ms from the start coincide.
9. Adjust Phase R9 so that minimum of the collector waveform occurs midway through the base pulse, or as near as possible without upsetting the pulse shape.
10. Repeat 8 and 9 to verify the setting of R3 and R9 respectively. Disconnect oscilloscope.
11. Adjust STEPS to give two steps.
12. Set HORIZ VOLTS/DIV to 0.5.
13. Set VCE-VBE to VBE and check that the display has one dot on the Left, one on the Right and one or two in the centre.
14. Adjust STEP AMPLITUDE R24 so that the distance between the centre of the two dots and the R.H. dot is 4 divisions.
15. Adjust Step Equaliser R19 so the two centre dots obtained in 4.4.4.13 coincide.
16. Set HORIZ VOLTS/DIV to 2 and set L.H. 2nd dot to the 2nd division from the left.
17. Increase STEPS to obtain a display of 10 steps and re-adjust STEP AMPLITUDE R24 until the 2nd and 9th dot coincide with 2nd and 9th divisions.
18. Repeat 15 to check setting of R19.

4.4.5 CRT

1. Set HORIZ VOLTS/DIV to 10.
2. Set VCE-VBE to VCE and CURRENT/DIV to 10 μ A, and short emitter (E) to earth.
3. Adjust the COLLECTOR SUPPLY to obtain a horizontal deflection of 8 divisions.
4. Adjust Trace Rotation R454 to obtain a horizontal line. Remove the short (4.4.5.2).
5. Set COLLECTOR SUPPLY control fully anti-clockwise and connect signal generator to the emitter (E) socket. Set to 20kHz and adjust amplitude to obtain a vertical deflection of 8 divisions.
6. Adjust R662 to obtain a vertical line.
7. Adjust the COLLECTOR SUPPLY to obtain a horizontal deflection of 8 divisions.
8. Adjust IPS R301 to obtain the best 8 x 8 divisions raster. Adjust Astig and Focus as necessary. Disconnect the signal generator.
9. Check both Set Sen R135 and R652.

FAULT DIAGNOSIS CHART

FAULT	ACTION
1. POWER ON and GRATICULE lamps are not lit.	Check the following: FS451, LP451, LP452 and LP453.
2. INTENSITY, FOCUS and ASTIG controls are not operative.	Check the following: 112 volts supply line, zener D301 and R302-R306.
3. CRT heater does not glow.	Check T451 and CRT.
4. Trace rotation control is ineffective.	Check the following: -12 V supply line, Trace rotation coil and R454. Plug and socket connexion in main P.C. Board.
5. COLLECTOR SUPPLY is incorrect.	Check D401 through D404.
6. PEAK WATTS switch does not function properly.	Check SERIES RESISTOR. R401-R405, R407, R408, R411, R413 and R414.
7. Horizontal and Vertical POSITION controls are ineffective.	Check +6 and -6 V supply lines, R128, R645 and display amplifier circuits.
8. No spot on the display screen.	Check CRT supply voltages and display amplifier circuits.
9. No steps or incorrect amplitude and number of steps.	Check STEP GENERATOR circuit.

TABLE 1 STEP AMPLITUDE SWITCH S1 CONNECTIONS

SWITCH POSITION	VOLTAGE DIVIDER AND CURRENT RESISTORS
2 V	R26, R31, R35, R37, R44, R43 in parallel
1 V	R35, R37, R44, R43 in parallel and R26, R31 in series
0.5 V	R37, R44, R43 in parallel and R26, R31, R35 in series
0.2 V	R44, R43 in parallel and R26, R31, R35, R37 in series
0.1 V	R43 in parallel and R26, R31, R35, R37, R44 in series
S.C.O.C	
0.2 μ A	R14, R13, R17, R21, R22, R25, R29, R34, R36, R38, R39, R41, R42, R43, R44, R37, R35, R31, R26
0.5 μ A	R13, R17, R21, R22, R25, R29, R34, R36, R38, R39, R41, R42, R43, R44, R37, R35, R31, R26
1 μ A	R17, R21, R22, R25, R29, R34, R36, R38, R39, R41, R42, R43, R44, R37, R35, R31, R26
2 μ A	R21, R22, R25, R29, R34, R36, R38, R39, R41, R42, R43, R44, R37, R35, R31, R26
5 μ A	R22, R25, R29, R34, R36, R38, R39, R41, R42, R43, R44, R37, R35, R31, R26
10 μ A	R25, R29, R34, R36, R38, R39, R41, R42, R43, R44, R37, R35, R31, R26
20 μ A	R29, R34, R36, R38, R39, R41, R42, R43, R44, R37, R35, R31, R26
50 μ A	R34, R36, R38, R39, R41, R42, R43, R44, R37, R35, R31, R26
0.1 mA	R36, R38, R39, R41, R42, R43, R44, R37, R35, R31, R26
0.2 mA	R38, R39, R41, R42, R43, R44, R37, R35, R31, R26
0.5 mA	R39, R41, R42, R43, R44, R37, R35, R31, R26
1 mA	R41, R42, R43, R44, R37, R35, R31, R26
2 mA	R42, R43, R44, R37, R35, R31, R26
5 mA	R43, R44, R37, R35, R31, R26
10 mA	R26, R31
20 mA	R26

TABLE 2 HORIZ VOLTS/DIV SWITCH S401 CONNECTIONS
 * Resistors and Capacitors shown, form parallel combinations with R417 and C401 — C404

SWITCH POSITION	SECONDARY VOLTAGE SELECTED (Wafers Cb, Df and Db)	* RESERVOIR CAPACITORS AND DISCHARGING RESISTORS AT DC POSITION OF S405 (Wafer Bb)	ATTENUATOR RESISTORS			
			Connected to TR101 — Base		Connected to TR102 — Base	
			SERIES (Wafers Ab, Bf)	PARALLEL	SERIES (Wafer Af)	PARALLEL
0.1 V	2.5 — 0 — 2.5 V	C406, R409	R102	R109, R113, R114, R121, R122, R123, R118	R630	R112, R117, R119, R124, R107, R108
0.2 V	2.5 — 0 — 2.5 V	C406, R409	R102, R109	R113, R114, R121, R122, R123, R118	R630, R112	R117, R119, R124, R107, R108
0.5 V	5 — 0 — 5 V	C406, R409	R102, R109, R113	R114, R121, R122, R123, R118	R630, R112, R117	R119, R124, R107, R108
1 V	10 — 0 — 10 V	C406, C407, R406, R409	R102, R109, R113, R114	R121, R122, R123, R118	R630, R112, R117, R119	R124, R107, R108
2 V	20 — 0 — 20 V	C406, C407, R406, R409	R102, R109, R113, R114, R121	R122, R123, R118	R630, R112, R117, R119, R127	R107, R108
5 V	40 — 0 — 40 V	C407, R406	R102, R109, R113, R114, R121, R122	R123, R118	R630, R112, R117, R119, R124, R107	R108
10 V	80 — 0 — 80 V	C407, R406	R102, R109, R113, R114, R121, R122, R123	R118	R630, R112, R117, R119, R124, R107	GND
20 V	160 — 0 — 160 V	C407, R406	R102, R103, R109, R113, R114, R121, R122, R123	R118	R630, R112, R117, R119, R124, R107	GND
50 V	400 — 0 — 400 V		R102, R103, R104, R109, R113, R114, R121, R122, R123	R118	R630, R112, R117, R119, R124, R107	GND
100 V	800 V		R102, R103, R104, R105, R109, R113, R114, R121, R122, R123	R118	R630, R112, R117, R119, R124, R107	GND

SERIES RESISTOR VALUE CHART

VALUE OHMS	RESISTORS CONNECTED IN SERIES
0	
2.5	R401
10	R401, R402
65	R401, R402, R403
250	R401, R402, R403, R404
1 k	R401, R402, R403, R404, R405
6.5 k	R401, R402, R403, R404, R405, R407
25 k	R401, R402, R403, R404, R405, R407, R408
85 k	R401, R402, R403, R404, R405, R407, R408, R411
500 k	R401, R402, R403, R404, R405, R407, R408, R411, R413
1.7 M	R401, R402, R403, R404, R405, R407, R408, R411, R413, R414

TABLE 3 PEAK WATTS S404 AND SERIES RESISTOR S403 SWITCH CONNECTIONS

	PEAK WATTS S404 SETTING AND S403 WAFERS			
	0.1 W Bb	0.5 W Bf	2 W Af	10 W Ab
HORIZ VOLTS/DIV S401 SETTING	SELECTABLE RESISTOR VALUES			
0.1 V	65 — 1.7 M	10 — 500 k	2.5 — 85 k	0 — 25 k
0.2 V	65 — 1.7 M	10 — 500 k	2.5 — 85 k	0 — 25 k
0.5 V	65 — 1.7 M	10 — 500 k	2.5 — 85 k	0 — 25 k
1 V	250 — 1.7 M	65 — 500 k	10 — 85 k	2.5 — 25 k
2 V	1 k — 1.7 M	250 — 500 k	65 — 85 k	10 — 25 k
5 V	6.5 k — 1.7 M	1 k — 500 k	250 — 85 k	65 — 25 k
10 V	25 k — 1.7 M	6.5 k — 500 k	1 k — 85 k	250 — 25 k
20 V	85 k — 1.7 M	25 k — 500 k	6.5 k — 85 k	1 k — 25 k
50 V	500 k — 1.7 M	85 k — 500 k	25 k — 85 k	6.5 k — 25 k
100 V	1.7 M	500 k	85 k	25 k

TABLE 4 S601 SWITCH CONNECTIONS

SWITCH POSITION	WAFERS					Cd, Ct
	AI	Ab	BI	Bb		
5 nA	R616, R617, R618, R619, R621, R622, R623, R624, R625					
10 nA	R617, R618, R619, R621, R622, R623, R624, R625					
20 nA	R618, R619, R621, R622, R623, R624, R625					
50 nA	R619, R621, R622, R623, R624, R625					
0.1 μ A	R621, R622, R623, R624, R625					
0.2 μ A	R622, R623, R624, R625					
0.5 μ A	R623, R624, R625					
1 μ A	R624, R625					
2 μ A	R625					
5 μ A	D602, D601					
10 μ A	R613, R612, R611, R609, R608, R607, R606, R605, R604, R503, R602, R601, R614					
20 μ A	R612, R611, R609, R608, R607, R606, R605, R604, R603, R602, R601, R614					
50 μ A	R611, R609, R608, R607, R606, R605, R604, R603, R602, R601, R614					
0.1 mA	R609, R608, R607, R606, R605, R604, R503, R602, R601, R614					
0.2 mA	R608, R607, R606, R605, R604, R603, R602, R601, R614					
0.5 mA	R607, R606, R605, R604, R603, R602, R601, R614					
1 mA	R606, R605, R604, R603, R602, R601, R614					
2 mA	R605, R604, R603, R602, R601, R614					
5 mA	R604, R603, R602, R601, R614					
10 mA	R603, R602, R601, R614					
20 mA	R602, R601, R614					
50 mA	R601, R614					
0.1 A	R614					
0.2 A						
		Connects the input of the 100:1 attenuator provided by R625 & R627 to the resistors selected by wafer Af.	Connects output of 100:1 attenuator to base of TR601.	Connects TR102 base attenuator to the emitter of device under test via R628 and R629.	Connects TR102 base attenuator to emitter of TR602.	Disconnects the step output.

SECTION 5

COMPONENT LIST

Values of resistors are stated in Ohms or multiples of Ohms; ratings at 70°C are in Watts or sub-multiples of Watts. Carbon resistors are of 10% tolerance and 250 mW rating unless otherwise shown. Values of capacitors are stated in sub-multiples of farads; ratings at 70°C are in volts or kilovolts.

Whenever possible, exact replacements for components should be used, although locally available alternatives may be satisfactory for standard components.

Any order for replacement parts should include:

- | | |
|--------------------------------|--------------------------|
| 1. Instrument type | 4. Component part number |
| 2. Instrument serial number | 5. Component value |
| 3. Component circuit reference | |

Assembly Part Numbers are listed at the end of this chapter.

CIRCUIT REFERENCE BLOCKS

The table below gives the blocks of circuit references, so that the reader can relate the items listed in this chapter and their location in the circuitry and printed circuit boards in chapter 6.

Circuit Reference		Circuit	Fig.	P.C. Board No.
From	To			
1	100	Step Generator	3	96
101	200	Horizontal Amplifier	1	97
301	400	CRT	5	97
401	450	Collector Supply	4	98
451	500	Power Supply	5	97
601	700	Vertical Amplifier	2	97

ABBREVIATIONS

C Carbon	Ge Germanium	Si Silicon
CP Carbon preset	MF Metal film	SM Silver Mica
CV Carbon variable	MO Metal oxide	WW Wire-wound
CER Ceramic	PE Polyester	WWP Wire-wound preset
CT Ceramic trimmer	PP Polypropylene	WWV Wire-wound variable
CM Cermet thick film	PS Polystyrene	
E Electrolytic	Se Selenium	

All requests for repairs or replacement parts should be directed to the Tektronix Field Office or representative in your area. This procedure will assure you the fastest possible service.

Cir Ref	Part Number	Description			
		Value F	Type	Tol %	Rating V
C1	285-0773-00	100 n	PE	20	400
C2	285-0779-00	470 n	PE	20	100
C3	285-0800-00	10 n	PE	20	250
C4	285-0779-00	470 n	PE	20	100
C5	285-0850-01	1 n	PP	5	125
C6	285-0800-00	10 n	PE	20	250
C7	285-0850-01	1 n	PP	5	125
C8	285-0795-00	220 n	PE	20	250
C9	290-0505-00	47 μ	E		10
C11	290-0476-00	100 μ	E		40
C12	285-0800-00	10 n	PE	20	250
C13	290-0478-00	470 μ	E		63
C14	281-0157-00	5-5-65-5 p	PP		500
C101	285-0800-00	10 n	PE	20	250
C401	290-0504-00	4-7 μ	E		350
C402	290-0504-00	4-7 μ	E		350
C403	290-0504-00	4-7 μ	E		350
C404	290-0504-00	4-7 μ	E		350
C406	290-0479-00	1 m	E		25
C407	290-0474-00	22 μ	E		250

Cir Ref	Part Number	Description			
		Value F	Type	Tol %	Rating V
C451	285-0779-00	470 n	PE	20	100
C452	290-0477-00	220 μ	E		63
C453	290-0477-00	220 μ	E		63
C454	290-0502-00	15 μ	E		350
C455	290-0502-00	15 μ	E		350
C456	281-0817-00	20 n	CER		1-5 k
C457	281-0817-00	20 n	CER		1-5 k
C458	281-0817-00	20 n	CER		1-5 k
C459	290-0503-00	330 μ	E		160
C461	290-0377-00	1 m	E		16
C462	290-0502-00	15 μ	E		350
C463	290-0502-00	15 μ	E		350
C464	290-0502-00	15 μ	E		350
C465	290-0502-00	15 μ	E		350
C466	290-0377-00	1 m	E		16

Cir Ref	Part Number	Description				Tol %	Rating
		Value V	Type				
D1	152-0062-01	75	1N914	Si		75mA	
D2	152-0062-01	75	1N914	Si		75mA	
D3	152-0062-01	75	1N914	Si		75mA	
D4	152-0062-01	75	1N914	Si		75mA	
D5	152-0062-01	75	1N914	Si		75mA	
D6	152-0466-00	15	Zener	SI	5	330mW	
D7	152-0062-01	75	1N914	Si		75mA	
D8	152-0339-00	50	Rectifier	Si		500mA	
D9	152-0339-00	50	Rectifier	Si		500mA	
D10	152-0062-01	75	1N914	Si			

D101	152-0062-01	75	1N914	Si		75mA
D102	152-0062-01	75	1N914	Si		75mA

Clr Ref	Part Number	Value V	Description	Type	Tol %	Rating
D301	152-0555-00	91	Zener	Si	5	770 mW
D401	152-0743-00	1 k 3	BY133	Si		1 A
D402	152-0743-00	1 k 3	BY133	Si		1 A
D403	152-0743-00	1 k 3	BY133	Si		1 A
D404	152-0743-00	1 k 3	BY133	Si		1 A
D451	152-0468-00	150	Mullard BAX16	Si		200 mA
D452	152-0468-00	150	Mullard BAX16	Si		200 mA
D453	152-0374-00	3-4 k	Rectifier	Se		0-6 mA
D454	152-0374-00	3-4 k	Rectifier	Se		0-6 mA
D455	152-0062-01	75	1N914	Si		75 mA
D456	152-0062-01	75	1N914	Si		75 mA
D457	152-0352-00	800	Rectifier	Si		200 mA
D458	152-0352-00	800	Rectifier	Si		200 mA
D459	152-0352-00	800	Rectifier	Si		200 mA
D461	152-0352-00	800	Rectifier	Si		200 mA
D462	152-0348-00	6-2	Zener	Si	5	330 mW
D463	152-0348-00	6-2	Zener	Si	5	330 mW
D601	152-0421-00	3-3	Zener	Si		330 mW
D602	152-0421-00	3-3	Zener	Si		330 mW
D603	152-0467-00	50	Rectifier	Si		3 A
D604	152-0467-00	50	Rectifier	Si		3 A

Clr Ref	Part Number	Value	Description	Type	Rating
FS1	159-0099-00	250 mA		1-25 in. fast	
FS401	159-0077-00	250 mA		1-25 in. delay	
FS451	159-0077-00	250 mA (200-250 V)		1-25 in. delay	

Cir Ref	Part Number	Value	Description	Type	Rating
FS601	159-0069-00	2 A		1-25 in. fast	
L301	108-0716-00	2 k		Trace rotation coil 3400 turns	
LP451	150-0095-00	14 V		LES	750 mW
LP452	150-0095-00	14 V		LES	750 mW
LP453	150-0095-00	14 V		LES	750 mW

Cir Ref	Part Number	Value	Type	Tol %	Rating W	Cir Ref	Part Number	Value	Type	Tol %	Rating W
R1	315-0103-01	10 k	CF	5	250m	R30	315-0273-02	27 k	CF	5	250m
R2	315-0154-01	150 k	CF	5	250m	R31	323-0097-40	100	MF	1	500m
R3	311-0910-00	2-2 M	CP	20	250m	R32	315-0101-02	100	CF	5	250m
R4	315-0274-02	270 k	CF	5	250m	R33	315-0103-01	10 k	CF	5	250m
R5	315-0182-01	1-8 k	CF	5	250m	R34	325-0240-00	20 k	MF	1	100 m
R6	315-0103-01	10 k	CF	10	250m	R35	325-0236-00	100	MF	1	100 m
R7	315-0823-02	82 k	CF	5	250m	R36	325-0309-00	10 k	MF	1	100 m
R8	315-0184-00	180 k	CF	5	250m	R37	325-0286-00	60-4	MF	1	100 m
R9	311-0851-00	1 k	CP	20	250m	R38	321-0268-48	6-04 k	MF	1	125 m
R10	315-0822-02	8-2 k	CF	5	250m	R39	325-0232-00	2 k	MF	1	100 m
R11	315-0822-02	8.2 k	CF	5	250m	R40	315-0222-01	2-2 k	CF	5	250 m
R12	315-0823-02	82 k	CF	5	250m	R41	325-0233-00	1 k	MF	1	100 m
R13	323-0510-40	2 M	MF	1	500m	R42	325-0234-00	604	MF	1	100 m
R14	323-0556-40	6-04 M	MF	1	500m	R43	321-0030-48	20	MF	1	100 m
R15	315-0103-01	10 k	CF	5	250m	R44	321-0030-48	20	MF	1	250 m
R16	315-0223-01	22 k	CF	5	250m	R45	315-0152-02	1-5 k	CF	5	100 m
R17	321-0481-48	1 M	MF	1	125m	R46	311-1143-00	10 k	CV	20	250m
R18	315-0184-00	180 k	CF	5	250m	R47	316-0106-01	10 M	C	10	250m
R19	311-0735-00	10 k	CP	20	250m	R48	315-0104-01	100 k	CF	5	250m
R20	315-0184-00	180 k	CF	5	250m	R49	315-0105-02	1 M	CF	5	250m
R21	321-0460-48	604 k	MF	1	125m						
R22	321-0414-48	200 k	MF	1	125m	R51	325-0294-00	1-3 k	MF	1	100 m
R23	315-0184-00	180 k	CF	5	250m	R52	311-0719-00	470	CP	20	250 m
R24	311-0809-00	1 M	CP	20	250m	R53	325-0294-00	1-3 k	MF	1	100 m
R25	325-0242-00	100 k	MF	1	100m	R54	315-0122-02	1-2 k	CF	5	250m
R26	308-0653-00	100	WW	1	2-5	R55	315-0182-01	1-8 k	CF	5	250m
R27	315-0391-01	390	CF	5	250m	R56	315-0103-01	10 k	CF	5	250m
R28	311-1072-00	2-2 k	CV	20	250m	R57	315-0105-02	1 M	CF	5	250m
R29	321-0364-48	60-4 k	MF	1	125m						

Cir Ref	Part Number	Description			Rating W	Cir Ref	Part Number	Description			Rating W
		Value Ohms	Type	Tol %				Value Ohms	Type	Tol %	
R60	315-0271-02	270	CF	5	250 m						
						R151	315-0272-01	2.7 k	CF	5	250m
R100	315-0102-02	1 k	CF	5	250m						
R101	316-0108-01	10 M	C	10	250m						
R102	321-0478-48	931 k	MF	1	125 m						
R103	321-0481-48	1 M	MF	1	125 m						
R104	323-0783-40	3 M	MF	1	500 m						
R105	323-0548-40	4.99 M	MF	1	500 m	R301	311-0765-00	100 k	CP	20	250 m
R106	321-0328-48	25.5 k	MF	1	125 m	R302	311-1142-00	100 k	CV	20	250 m
R107	321-0100-48	107	MF	1	125 m	R303	316-0185-01	1.8 M	C	10	250 m
R108	321-0082-48	69.8	MF	1	125 m	R304	311-1157-00	1 M	CV	20	250 m
R109	321-0349-48	42.2 k	MF	1	125 m	R305	315-0564-01	580 k	CF	5	250m
						R306	311-1157-00	1 M	CV	20	250 m
R111	316-0565-01	5.8 M	C	10	250m						
R112	321-0844-48	2.2 k	MF	1	125 m						
R113	321-0324-48	23.2 k	MF	1	125 m						
R114	321-0276-48	7.32 k	MF	1	125 m						
R115	316-0106-01	10 M	C	10	250m						
R116	316-0226-01	22 M	C	10	250m						
R117	321-0200-48	1.18 k	MF	1	125 m						
R118	325-0217-00	732	MF	1	100 m						
R119	321-0152-48	374	MF	1	125 m						
R121	321-0848-48	3.6 k	MF	1	125 m	R401	308-0650-00	2.4	WW	5	6
R122	321-0225-48	2.15 k	MF	1	125 m	R402	308-0651-00	7.5	WW	5	6
R123	321-0179-48	715	MF	1	125 m	R403	308-0652-00	56	WW	5	9
R124	321-1121-48	180	MF	1	125 m	R404	308-0654-00	180	WW	5	9
R125	321-0321-48	21.5 k	MF	1	125 m	R405	308-0655-00	750	WW	5	9
R126	321-0363-48	59 k	MF	1	125 m	R406	303-0104-01	100 k	C	5	1
R127	311-0735-00	10 k	CP	20	250 m	R407	308-0656-00	5.6 k	WW	5	9
R128	311-1074-00	22 k	CV	20	250 m	R408	308-0657-00	18 k	WW	5	9
R129	315-0274-02	270 k	CF	10	250m	R409	315-0152-02	1.5 k	CF	5	250m
R131	311-0765-00	100 k	CP	20	250 m	R411	307-0261-00	65 k	MO	5	5
R132	311-1070-00	4.7 M	CP	30	75 m						
R133	321-0886-48	680 k	MF	1	125 m	R413	303-0474-01	470 k	C	5	1
R134	315-0683-02	68 k	CF	5	250m	R414	316-0155-01	1.5 M	C	10	250m
R135	311-1093-00	150 k	CV	20	250m	R415	303-0334-01	330k	C	5	1 W
R136	315-0753-01	75 k	CF	5	250m	R416	303-0334-01	330k	C	5	1 W
R137	315-0104-01	100 k	CF	5	250m	R417	316-0275-01	2.7 M	C		
R138	321-0312-48	17.4 k	MF	1	125 m						
R139	311-1188-00	33 k	CP	20	250 m						
R141	315-0104-01	100 k	CF	5	250m						
R142	315-0152-02	1.5 k	CF	5	250m						
R143	311-0896-00	3.3 k	CP	20	250m						
R144	315-0753-01	75 k	CF	5	250m						
R145	303-0153-01	15 k	C	5	1						
R146	315-0820-02	82	CF	5	250m						
R147	315-0272-01	2.7 k	CF	5	250m						
R148	315-0471-01	470	CF	5	250m	R451	311-1071-00	100	CV	20	2
R149	303-0153-01	15 k	C	5	1	R452	315-0820-02	82	CF	5	250m

Cir Ref	Part Number	Description			Rating W
		Value Ohms	Type	Tol %	
R453	315-0680-01	68	CF	5	250m
R454	311-0932-00	500	CP	20	250m
R455	315-0273-02	27 k	CF	5	250m
R456	315-0331-02	330	CF	5	250m
R457	315-0103-01	10 k	CF	5	250m
R458	315-0472-02	4.7 k	CF	5	250m
R459	311-0798-00	2.2 k	CP	20	250m
R461	315-0471-01	470	CF	5	250m
R462	315-0152-02	1.5 k	CF	5	250m

Cir Ref	Part Number	Description			Rating W
		Value Ohms	Type	Tol %	
R623	325-0201-00	499	MF	1	250 m
R624	325-0202-00	300	MF	1	250 m
R625	325-0287-00	200	MF	1	100 m
R626	321-0298-48	12.4 k	MF	1	125 m
R627	321-0106-48	124	MF	1	125 m
R628	311-0735-00	10 k	CP	20	250 m
R629	321-0321-48	21.5 k	MF	1	125 m
R630	321-0320-48	21 k	MF	1	125 m
R631	315-0394-02	390 k	CF	5	250m
R632	311-0765-00	100 k	CP	20	250 m
R633	307-0186-00	22 M	C	20	250 m
R634	321-0853-48	220 k	MF	1	125 m
R635	311-1069-00	150 k	CP	20	250 m
R636	316-0225-01	2.2 M	C	10	250m
R637	311-1091-00	6.8 k	CP	20	250 m
R638	315-0564-01	560 k	CF	5	250m
R639	315-0103-01	10 k	CF	5	250m

R601	308-0648-00	0.5	WW	1	2.5
R602	308-0649-00	1	WW	1	2.5
R603	308-0669-00	3	WW	1	2.5
R604	308-0670-00	4.99	WW	1	2.5
R605	308-0671-00	10	WW	1	2.5
R606	308-0672-00	30	WW	1	2.5
R607	308-0673-00	51	WW	1	2.5
R608	308-0674-00	102	WW	1	2.5
R609	308-0675-00	324	WW	1	2.5

R641	315-0684-01	680 k	CF	5	250m
R642	311-0765-00	100 k	CP	20	250m
R643	315-0224-02	220 k	CF	5	250m
R644	315-0274-02	270 k	CF	5	250m
R645	311-1092-00	500 k	CV	20	250m
R646	315-0823-02	82 k	CF	5	250m
R647	316-0565-01	5.6 M	C	10	250m
R648	315-0104-01	100 k	CF	5	250m
R649	315-0152-02	1.5 k	CF	5	250m
R650	311-0798-00	2.2 k	CP	20	250m
R651	315-0104-01	100 k	CF	5	250m
R652	311-1073-00	5 M	CP	20	250m
R653	315-0224-02	220 k	CF	5	250m
R654	315-0274-02	270 k	CF	5	250m
R655	303-0153-01	15 k	CF	5	1
R656	315-0272-01	2.7 k	CF	5	250m
R657	315-0471-01	470	CF	5	250m
R658	315-0820-02	82	CF	5	250m
R659	303-0153-01	15 k	CF	5	1

R611	321-0171-48	590	MF	1	125 m
R612	321-0207-48	1.4 k	MF	1	125 m
R613	321-0277-48	7.5 k	MF	1	125 m
R614	308-0648-00	0.5	WW	1	2.5
R616	321-0397-48	133 k	MF	1	125 m
R617	321-0351-48	44.2 k	MF	1	125 m
R618	321-0296-48	11.8 k	MF	1	125 m
R619	321-0263-48	5.36 k	MF	1	125 m
R621	321-0240-48	3.09 k	MF	1	125 m
R622	321-0194-48	1.02 k	MF	1	125 m

R661	315-0272-01	2.7 k	CF	5	250m
R662	311-0801-00	470 k	CP	20	250m
R663	315-0184-01	180 k	CF	5	250m

Cir Ref	Part Number	Description
S1	260-1160-00	Rotary (23 — position)
S2	260-1161-00	Lever (2 — position)
S101	260-1156-01	Toggle (3 — position)
S102	260-1161-00	Lever (2 — position)
S401	260-1157-01	Rotary (10 — position)
S402	260-1162-00	Lever (2 — position)
S403	260-1158-00	Rotary (8 — position)
S404	260-1205-00	Lever (4 — position)
S405	260-1184-00	Lever (2 — position)

Cir Ref	Part Number	Description
S451	311-1071-00	2 — pole (with R451)
S601	260-1159-00	Rotary (24 — position)
T401	120-0668-00	Variable transformer
T402	120-0666-00	Transformer
T451	120-0667-00	Power transformer

Clr Ref	Part Number	Value Ohms	Type	Tol %	Rating W
TH101	307-0258-00	130	Thermistor VA1040	20	500 m
TH451	307-0288-00	1.3 k	Thermistor VA1038	20	500 m
TH601	307-0258-00	130	Thermistor VA1040	20	500 m

Clr Ref	Part Number	Description	Type
TR1	151-0127-02	2N2369	NPN
TR2	151-0127-02	2N2369	NPN
TR3	151-0320-01	MPS 6518	PNP
TR4	151-0320-01	MPS 6518	PNP
TR5	151-0326-01	BC107	NPN
TR6	151-0326-01	BC107	NPN
TR7	151-0326-01	BC107	NPN
TR8	151-0692-00	BD419	NPN
TR9	151-0404-00	MPS 2907A	PNP
TR10	151-0320-01	MPS 6518	PNP
TR11	151-0692-00	BD419	NPN

TR101	151-0317-01	BC109C	NPN
TR102	151-0317-01	BC109C	NPN
TR103	151-0317-01	BC109C	NPN
TR104	151-0317-01	BC109C	NPN
TR105	151-0525-00	FRB749L/SO4-3239	NPN
TR106	151-0525-00	FRB749L/SO4-3239	NPN

TR601	151-0317-01	BC109C	NPN
TR602	151-0404-00	MPS 2907A	PNP
TR603	151-0317-01	BC109C	NPN
TR604	151-0317-01	BC109C	NPN
TR605	151-0317-01	BC109C	NPN
TR606	151-0525-00	FRB749L/SO4-3239	NPN
TR607	151-0525-00	FRB749L/SO4-3239	NPN

V301	154-0683-01	CRT Type D16-100 GH
------	-------------	---------------------

ASSEMBLY PART NUMBERS

Assembly	Part Number	Includes Circuit References
Graticule Lamps	352-0160-02	LP452, LP453
Lead, 12" long PDA	131-1027-00	
PC.96 Step Generator	670-1306-02	C1 to C9, C11 to C14, D1 to D10, R1 to R12, R15, R16, R18 to R20, R23, R24, R27, R30, R32, R33, R40, R45, R47 to R49, R51 to R57, TR1 to TR7, TR9, TR10
PC.97 CRT, power supply, horizontal and vertical amplifier	670-1307-00	C101, C451 to C459, C461 to C466, D101, D102, D451 to D459, D461 to D463, D601 to D604, R111, R115, R116, R127, R129, R131 to R134, R136 to R139, R141 to R149, R151, R301, R452, R453, R455 to R459, R461, R462, R628, R629, R631 to R639, R641 to R644, R646 to R651, R653 to R659, R661 to R663, TH101, TH451, TH601, TR101 to TR106, TR601 to TR607
PC.98 Collector supply	670-1308-00	C401 to C404, C406, C407, D401 to D404, R406, R409, R415 to R417
Switch S1, Step amplitude	262-0947-00	R13, R14, R17, R21, R22, R25, R26, R29, R31, R34 to R39, R41 to R44
Switch S401, Horiz Volts/Div	262-0945-00	R100, R102 to R109, R112 to R114, R117 to R119, R121 to R126
Switch S403, Series resistor	262-0948-00	R401 to R405, R407, R408, R411, R413, R414
Switch S601 Current/Div	262-0946-00	R601 to R609, R611 to R614, R616 to R619, R621 to R627, R630
Test fixture, TO3 — TO66	013-0119-00	
Test fixture, TO5 — TO18	013-0120-00	
Test accessory	331-0321-00	Cursor fitted inside front cover.

MECHANICAL

Description	Part number
Cabinet side	390-0185-00
Power cord set	161-0136-00
Cable, power with socket, (black—white—green (USA option 6)	161-0085-00
Cap, EHT (PDA connector)	200-2016-00
Clamp, handle holding	343-0212-00
Connector, CRT PDA button	134-0157-00
Cover Elec. moulded	200-2208-01
Cover graticule assembly	200-1188-00
Cover, rear	390-0186-00
Filter, light blue	378-0679-01
Foot, front	348-0463-01
Foot, rear	348-0168-00
Graticule	331-0278-00
Handle (Black)	367-0101-01
Heatsink 6047 PB	214-3147-00
Holder, fuse FS1, FS401, FS601	352-0265-00
Holder, fuse FS451	352-0499-00
Holder, lamp LP451	136-0311-00
Knob, grey: Series resistor	366-1289-00
Knob, grey: Step amplitude, Current/Div	366-1302-00
Knob, grey	366-1301-00
Knob, lever, grey	366-0215-02
Knob, transparent: Horiz volts/Div	366-1288-00
Nut, knurled, cover graticule	220-0513-00
Panel, front	333-1390-00
Panel, rear	333-1392-01
Plug, supply voltage selector	134-0102-00
Plug, trace rotation coil	134-0100-00
Safety bottom cover	200-1189-02
Screw M2 x 4mm pan	213-0802-00
Sleeve black rubber	361-0266-00
Socket, base CRT	136-0302-00
Socket, supply voltage selector	136-0315-00
Socket transistor 3 pin	136-0343-01
Spacer hex 7/8 6BA	166-0465-00
Spacer mtg 6BA	129-0706-00
Tape Insulator	253-0133-00
Trim, chrome band	101-0019-00
Washer lock 6BA	210-1210-00
Washer Plain M2	210-1290-00
Socket Transistor TO220	136-0709-00
Switch Current Div	260-1159-00

SECTION 6

CIRCUIT DIAGRAMS

To minimize the risk of misinterpretation of component values on circuit diagrams, the decimal point has been replaced by the multiplier or sub-multiplier of the basic unit. For instance, 2.2 megohms is shown as 2M2 and 1.8 picofarads is shown as 1p8.

To aid the reader further, in addition to the block Circuit Reference Table in Section 5.1, to locate a component in the circuit diagrams, a table is provided at the top of each circuit diagram, in which the circuit reference will appear, where practicable, directly above the component being sought.

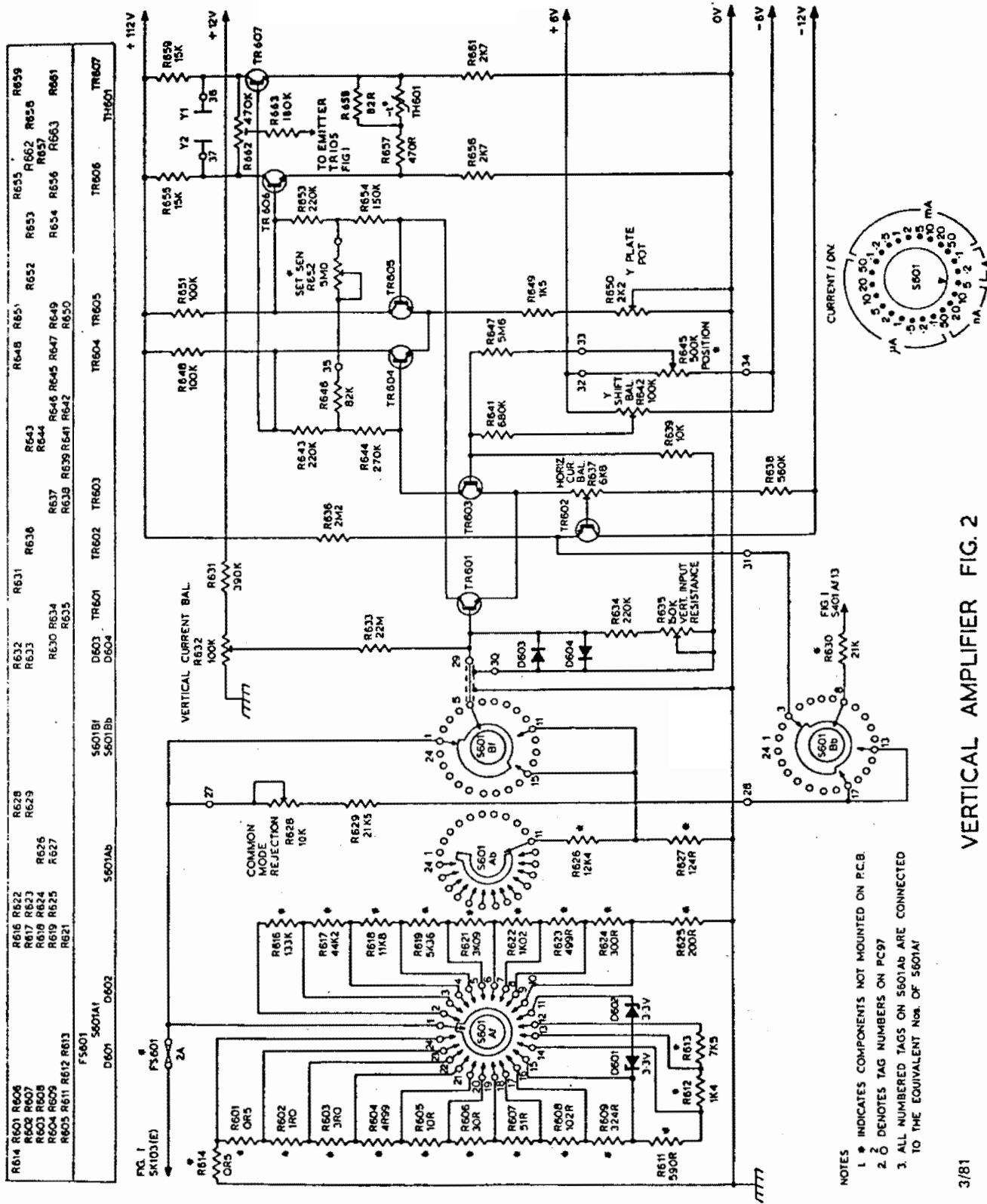

- NOTES
- 1 * INDICATES COMPONENTS NOT MOUNTED ON P.C.B.
 - 2 O DENOTES TAG NUMBERS ON PC97
 3. ALL NUMBERED TAGS ON 5601AB ARE CONNECTED TO THE EQUIVALENT Nos. OF 5601A1

VERTICAL AMPLIFIER FIG. 2

R2	R5	P19	R15	R23	R27	R32	R37	R40	R41	R45	R51	C13	C14	
R1	R4	R3	R8	R11	R1C	R15	R2C	R24	R33	R30	R42	R46	D7	D9
R10	R7	R9	R2	R12	R14	R21	R22	R29	R34	R38	R43	R48	D8	D10
C1	C2	C3	C4	C5	C6	C7	C8	C9	C10	C11	C12	C15	D6	D10
TR1	SIAB	TR2	.01	D2	TR3	TR4	TR5	D4	TR6	TR7	TR8	SE	TR9	TR11
			FS1	S1A1					D5					

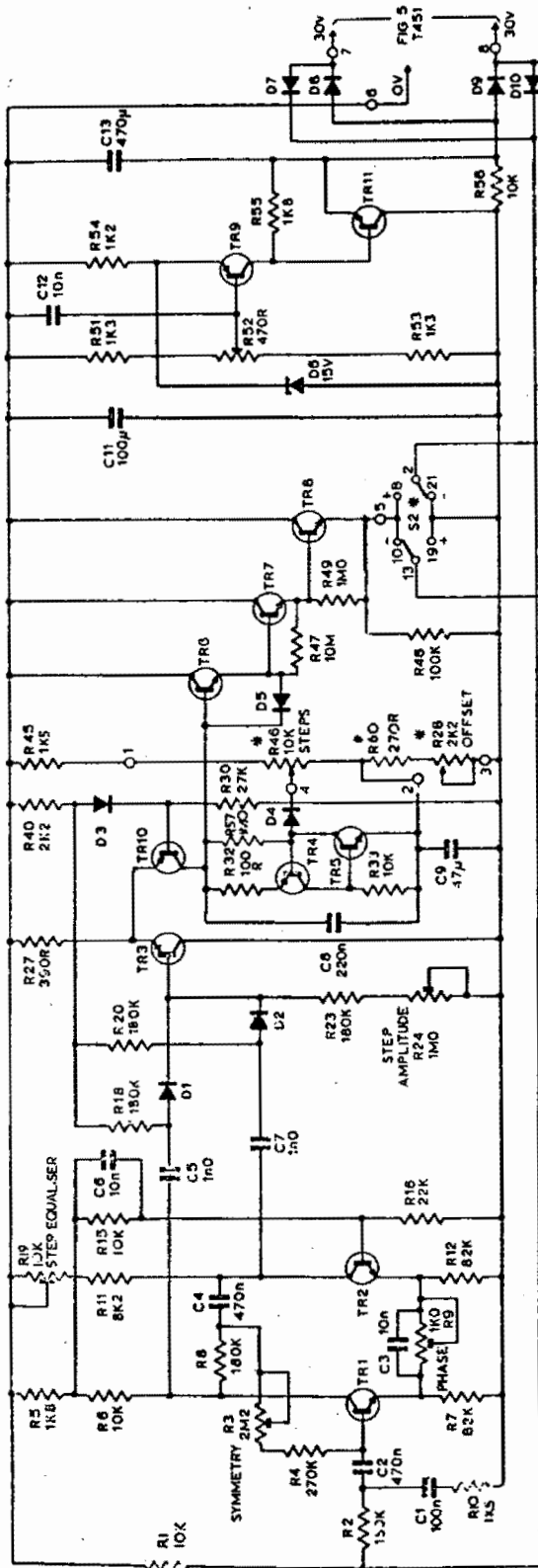

NOTES
 1 * INDICATES COMPONENTS NOT MOUNTED ON P.C.B.
 2 O DENOTES TAG NUMBERS ON PC96

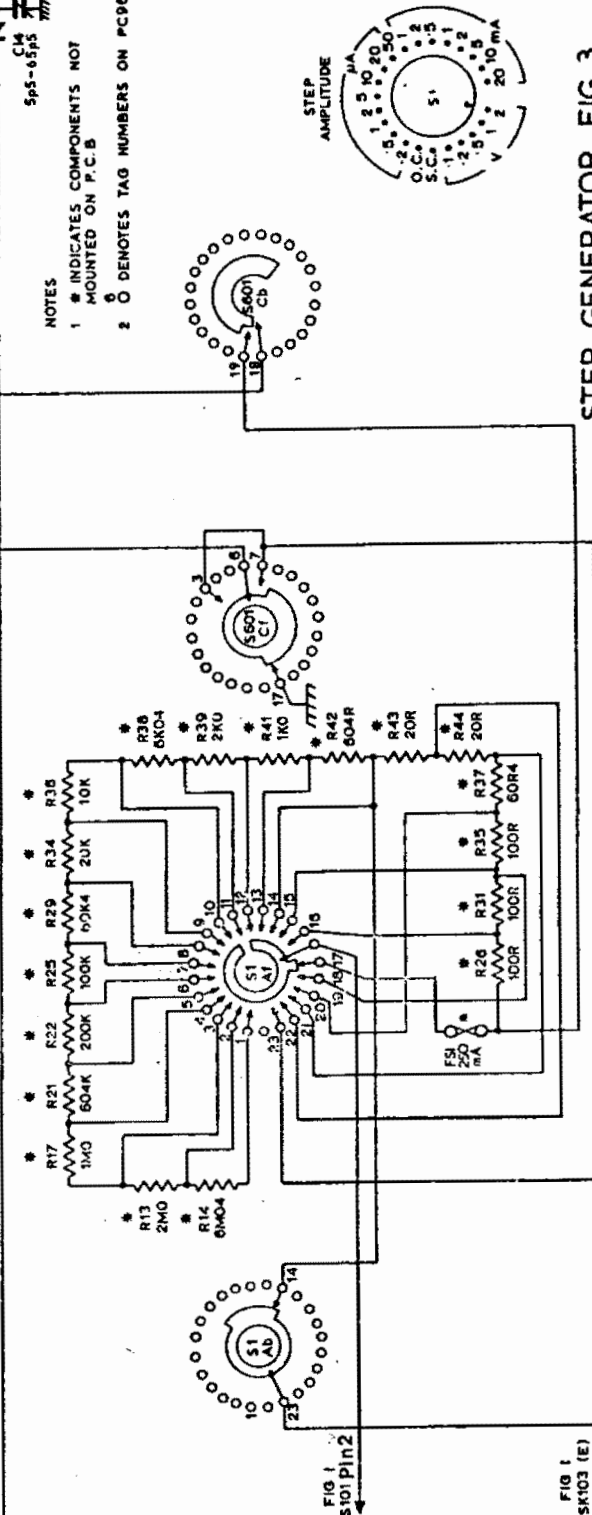
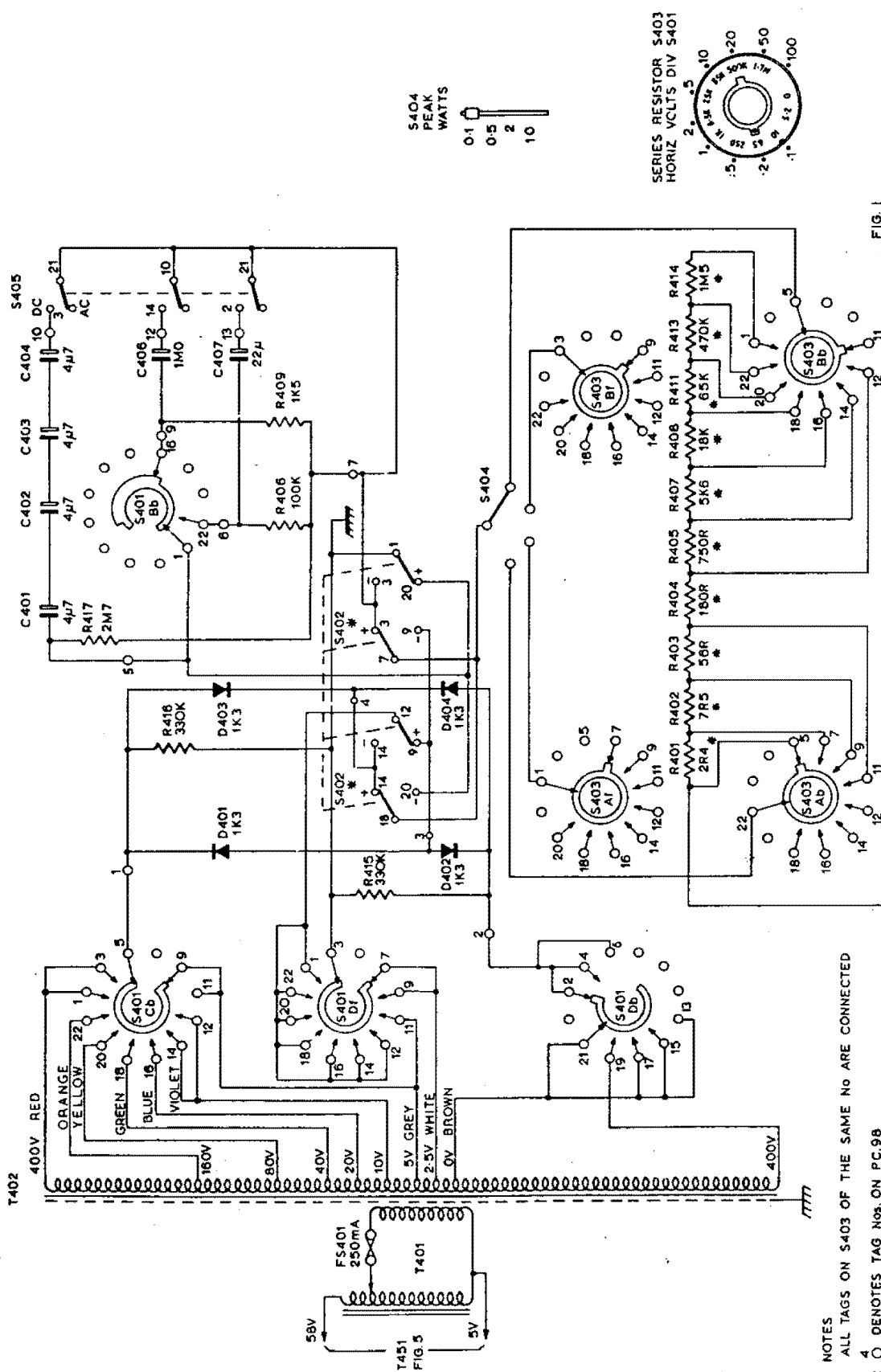

FIG. 1 SK103 (E)

FIG. 1 SK103 (E)

STEP GENERATOR FIG. 3

R415	R416	R417	R406	R409
R401	R402	R403	R404	R405
R407	R408	R411	R413	R414
C401	C402	C403	C404	C406
C407	S401	S402	S403 Bb	S405
S401 Bb	S404	S403 Bf	S403 Bb	S403 Bb
S401 Cb	D401	D403	S401 Bb	S405
S401 Df	S403 Af	S402	S403 Bb	S405
S401 Db	D402	D404	S403 Bb	S405
T402				
FS401				
T401				



S404
PEAK
WATTS
0.1
0.5
2
10

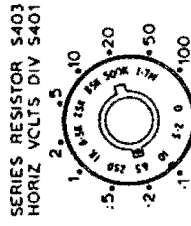

NOTES
1 ALL TAGS ON S403 OF THE SAME No ARE CONNECTED
2 O DENOTES TAG Nos. ON PC.98
3 * INDICATES COMPS NOT ON P.C.B.

COLLECTOR SUPPLY FIG. 4

FIG. 1
S101 pin 8

SKT451	FS451	T451	R452	R453	R454	R455	R456	R457	R458	R459	R460	R461	R462	R301	R302	R303	R304	R305	R306	V301	L301
S451	PL451	D451	C452	C453	C454	C455	C456	C457	C458	C459	C460	C461	C462	C463	C464	C465	C466	D467	D468	D301	D302
		D452	LP451	LP452	LP453	D453	D454	D455	D456	D457	D458	D459	D460	D461	D462	D463	D464	D465	D466	D467	D468

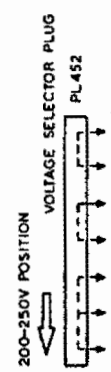
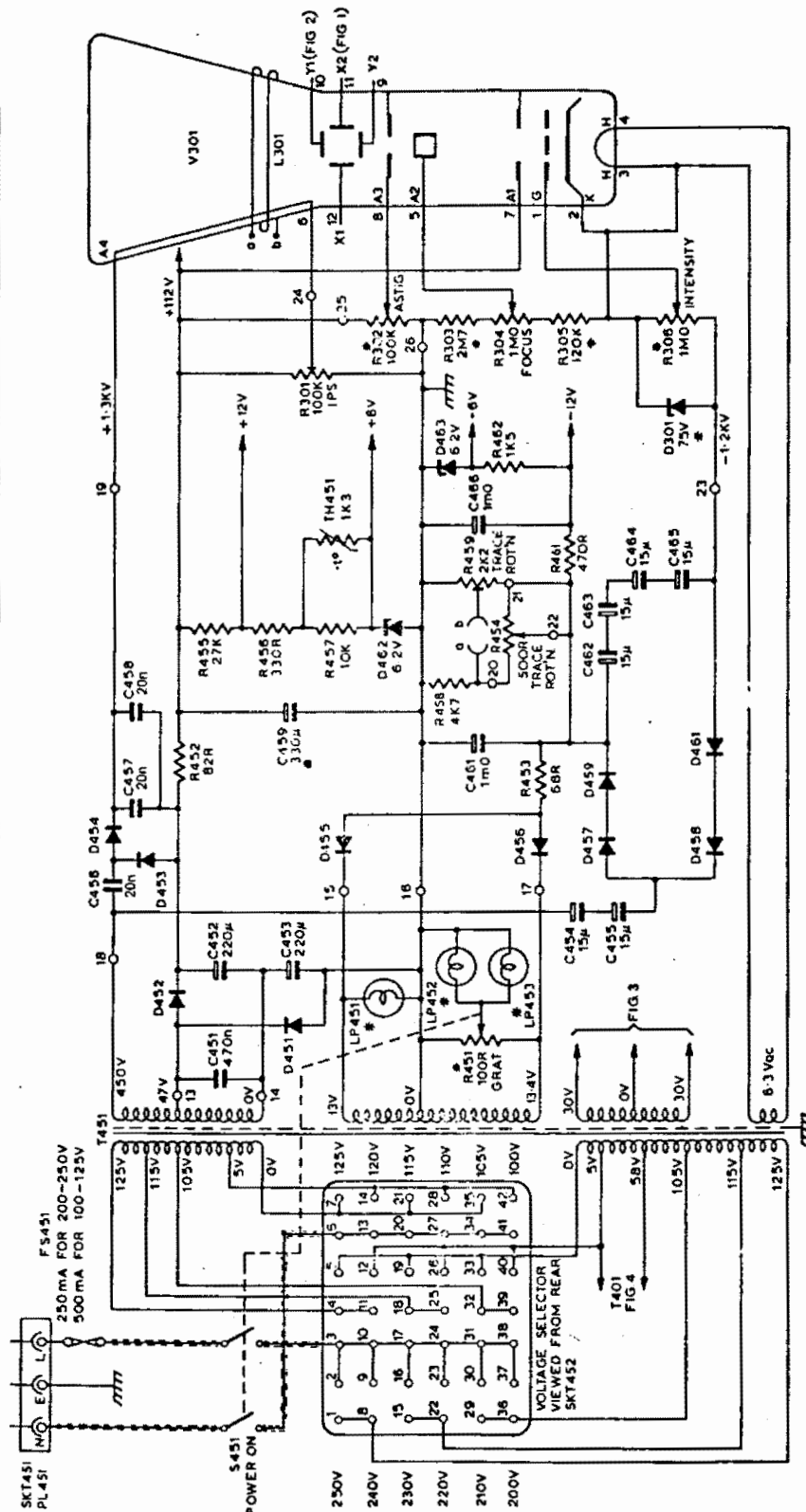

- NOTES:-
- 1 * DENOTES COMPONENTS NOT MOUNTED ON P.C.B
 - 2 ∅ INDICATES TAG NUMBERS ON PC 97

POWER SUPPLY & CRT CIRCUIT FIG.5

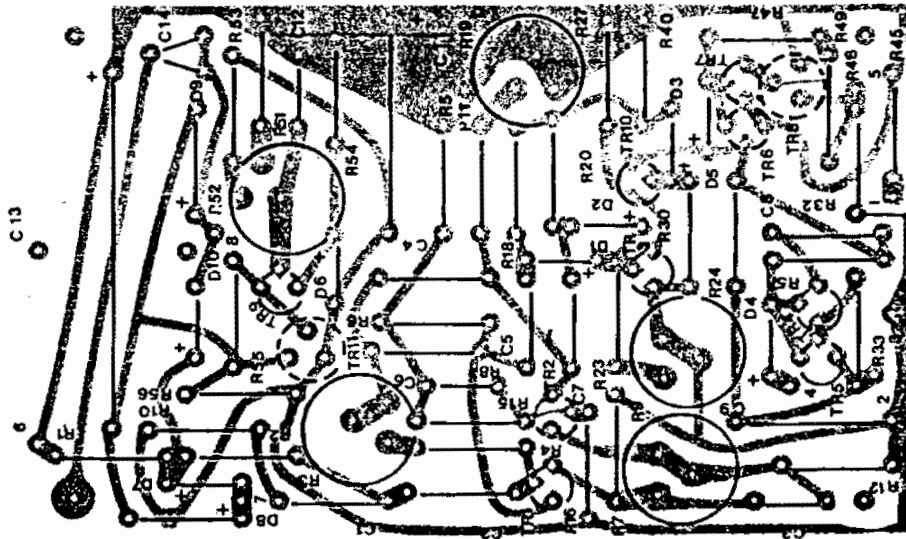

PC96 Component Reference
Fig. 6

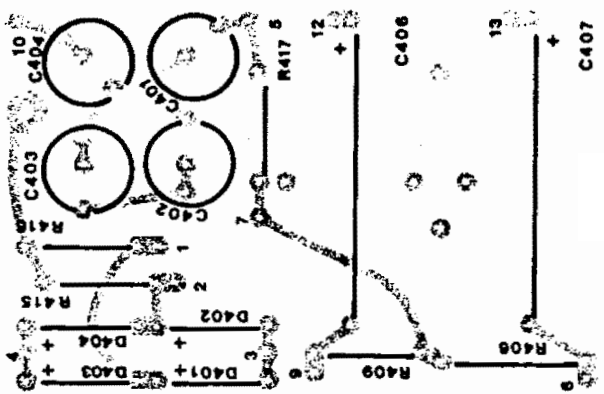

PC98 Component Reference
Fig. 7

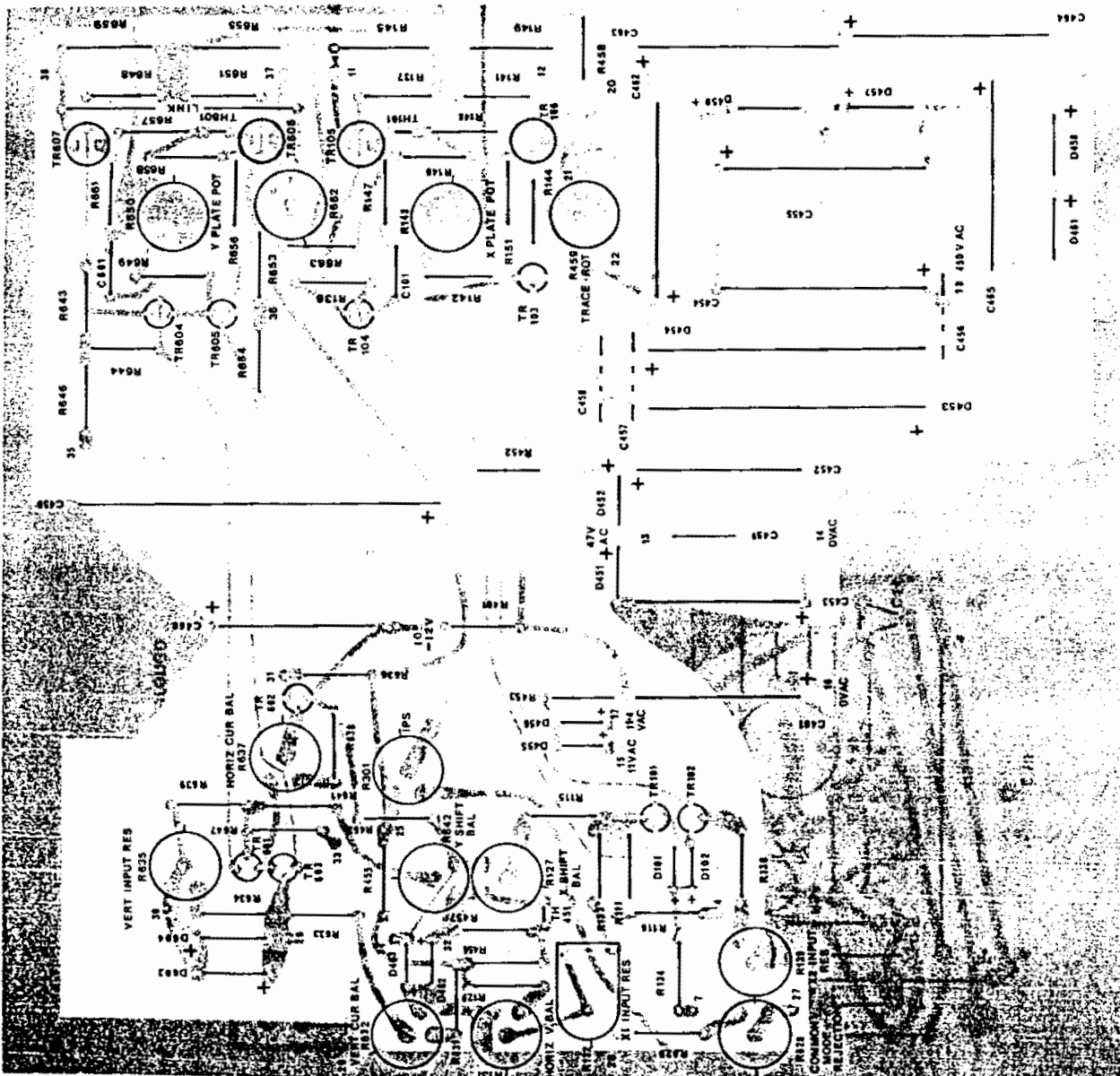

PC97 Component Reference
Fig. 8